



European  
Commission

JRC SCIENTIFIC AND POLICY REPORTS

# Prospective Scenarios on Energy Efficiency and CO<sub>2</sub> Emissions in the EU Iron & Steel Industry

N. Pardo, J.A. Moya, K. Vatopoulos

**2012**



Report EUR 25543 EN

Joint  
Research  
Centre

**European Commission**

Joint Research Centre  
*Institute for Energy and Transport*

**Contact information**

J.A. Moya

Address: Joint Research Centre, Westerduinweg 3, NL-1755 LE Petten, The Netherlands

E-mail: Jose.Moya@ec.europa.eu

Tel.: +31 224 56 5244

Fax: +31 224 56 5600

<http://iet.jrc.ec.europa.eu/>

<http://www.jrc.ec.europa.eu/>

This publication is a Reference Report by the Joint Research Centre of the European Commission.

**Legal Notice**

Neither the European Commission nor any person acting on behalf of the Commission is responsible for the use which might be made of this publication.

Europe Direct is a service to help you find answers to your questions about the European Union  
Freephone number (\*): 00 800 6 7 8 9 10 11

(\*): Certain mobile telephone operators do not allow access to 00 800 numbers or these calls may be billed.

A great deal of additional information on the European Union is available on the Internet.  
It can be accessed through the Europa server <http://europa.eu/>.

JRC74811

EUR 25543 EN

ISBN 978-92-79-26971-4 (pdf)

ISBN 978-92-79-26972-1 (print)

ISSN 1018-5593 (print)

ISSN 1831-9424 (online)

doi:10.2790/64264

Luxembourg: Publications Office of the European Union, 2012

© European Union, 2012

Reproduction is authorised provided the source is acknowledged.

*Printed in The Netherlands*

*Cover photographs: Tube production, source: Benteler Steel (left), Cold-rolled sheets, source: ThyssenKrupp Steel (right)*

## TABLE OF CONTENTS

<b>1. INTRODUCTION .....</b>	<b>7</b>
<b>2. BACKGROUND OF THE IRON &amp; STEEL INDUSTRY IN THE EU-27 .....</b>	<b>8</b>
2.1. Production routes in EU-27 .....	8
2.2. Steel consumption in EU-27 .....	10
2.3. Steel production in EU-27 .....	11
<b>3. IRON &amp; STEEL PRODUCTION - CURRENT, BEST AND INNOVATIVE TECHNOLOGIES .....</b>	<b>11</b>
3.1. Steel production in EU-27 – Current Technology .....	12
3.2. Best Available Technologies (BATs).....	14
3.3. Innovative Technologies (ITs).....	18
<b>4. METHODOLOGY AND MODEL.....</b>	<b>21</b>
4.1. Calibration of the model .....	21
4.2. Iron & steel production and demand projections .....	22
4.3. Scrap availability .....	23
4.4. Description of the new EAF plant.....	24
4.5. Retrofitting options: implementation of BATs and ITs .....	25
4.6. Iron & steel production costs .....	27
4.7. Scenarios.....	29
<b>5. SIMULATION RESULTS .....</b>	<b>30</b>
5.1. Baseline scenario - BS .....	30
5.2. Alternative Scenario 1 - AS1 .....	31
5.3. Alternative Scenario 2 - AS2 .....	33
5.4. Benchmarking curves and trend in specific energy consumption and CO <sub>2</sub> emissions .....	35
5.5. Policy implications .....	40
<b>6. CONCLUSIONS .....</b>	<b>41</b>
<b>7. BIBLIOGRAPHY .....</b>	<b>43</b>

## TABLES

<i>Table 1: Capacity share of the different crude steel production routes in the EU-27 countries in 2008, [28].</i>	9
<i>Table 2: Estimated specific energy consumption and specific CO<sub>2</sub> emissions per tonne of product of the current pathways for the Iron &amp; Steel production in Europe.</i>	13
<i>Table 3: Processes identified in the Iron &amp; Steel industry in EU-27.</i>	14
<i>Table 4: Overview of the possible BATs in the Iron &amp; Steel industry.</i>	14
<i>Table 5: Estimated reduction in specific energy consumption and specific CO<sub>2</sub> emission (per tonne of its corresponding product) of the BAT technologies.</i>	18
<i>Table 6: Estimated reduction in specific energy consumption and specific CO<sub>2</sub> emissions (per tonne of its corresponding product) of the IT technologies.</i>	20
<i>Table 7: Estimated specific energy consumption and specific CO<sub>2</sub> emissions per tonne of product of New EAF.</i>	25
<i>Table 8: Reference capacities and investment cost for each BAT and IT and expected availability date.</i>	27
<i>Table 9: Energy and resources prices for 2010 and annual growth up 2030 (n.a.: not applicable).</i>	28
<i>Table 10: Other cost prices for 2010 and annual growth up 2030.</i>	28

## FIGURES

<i>Figure 1: Primary and secondary steel production routes [26]</i> .....	9
<i>Figure 2: Apparent crude steel consumption per country in 2008</i> .....	10
<i>Figure 3: Steel consumption by sectors.</i> .....	10
<i>Figure 4: Crude steel production in the EU-27, in 2008</i> .....	11
<i>Figure 5: Current pathways for Iron &amp; Steel production in Europe</i> .....	12
<i>Figure 6: Ranking of the potential energy savings for BATs considered in this work</i> .....	16
<i>Figure 7: Schematic overview of the Iron &amp; Steel model</i> .....	21
<i>Figure 8: Adjustment of the benchmarking curves of the model to the real ones</i> .....	22
<i>Figure 9: Iron &amp; Steel production, demand and net export for EU27 up to 2030</i> .....	23
<i>Figure 10: Scrap requirements, scrap generation and scrap net import for the EU27</i> .....	24
<i>Figure 11: Historical number of mayor retrofits in the EU integrated steel route</i> .....	25
<i>Figure 12: Historical number of mayor retrofits in the EU integrated steel route</i> .....	26
<i>Figure 13: Total direct energy consumption and total direct CO<sub>2</sub> emissions on EU-27 Iron &amp; Steel Industry, and associated power plants, under the BS scenario up to 2030, whether retrofits are allowed or not.</i> .....	31
<i>Figure 14: Difference with the case without retrofits on direct energy consumption and direct CO<sub>2</sub> emissions by technology in the BS scenario for the EU-27 Iron &amp; Steel Industry, and associated power plants, up to 2030</i> .....	31
<i>Figure 15: Difference with the case without retrofits on direct energy consumption and direct CO<sub>2</sub> emissions by technology in the 2x - Fuel scenario for the EU-27 Iron &amp; Steel Industry, and associated power plants, up to 2030.</i>	32
<i>Figure 16: Difference with the case without retrofits on direct energy consumption and direct CO<sub>2</sub> emissions by technology in the 5x - Fuel scenario for the EU-27 Iron &amp; Steel Industry, and associated power plants, up to 2030.</i>	33
<i>Figure 17: Difference with the case without retrofits on direct energy consumption and direct CO<sub>2</sub> emissions by technology in the 100€ - CO<sub>2</sub> scenario for the EU-27 Iron &amp; Steel Industry, and associated power plants, up to 2030.</i> .....	34
<i>Figure 18: Savings, compared to the case without retrofits, on direct energy consumption and direct CO<sub>2</sub> emissions by technology in the 200€ - CO<sub>2</sub> scenario for the EU-27 Iron &amp; Steel Industry, and associated power plants up to 2030</i> .....	35



# 1. Introduction

In March 2007, the EU endorsed an integrated approach to climate and energy policy, the aim of which is to combat climate change and increase the EU's energy security, while strengthening its competitiveness. The policy committed Europe to transform itself into a highly energy-efficient, low carbon economy. To kick-start this process, the EU set a series of targets for climate change and energy to be met by 2020, which is referred to as the 20-20-20 target: this means at least a 20% reduction of greenhouse gas emissions below 1990 levels, 20% of energy consumption to come from renewable resources and a 20% reduction in primary energy use compared with projected levels, to be achieved by improvements in energy efficiency [1]. In 2008, the EU Strategic Energy Technology Plan (SET-Plan) was adopted as the technology pillar of the EU's climate change and energy policy in order to accelerate the development of a world-class portfolio of affordable, clean, efficient and low-emission energy technologies through coordinated research efforts [2]. In order to keep climate change below 2°C, the European Council reconfirmed in February 2011 the EU objective of reducing greenhouse gas emissions by 80-95% by 2050 compared to 1990.

The Europe 2020 program has at its core the conviction that Europe's industrial base needs to be re-oriented towards a more sustainable future, and to seize the opportunities provided by Europe's early investment in green technologies [3]. It is noted that the competitiveness of the Community's industry is also a central element of the Integrated Pollution Prevention and Control Directive related to environmental protection [4]. This directive highlights the importance of energy-intensive industries, especially those emitting large amounts of CO<sub>2</sub>.

The iron & steel industry is one of the biggest industrial emitters of CO<sub>2</sub>. It is estimated that between 4 and 7% of the anthropogenic CO<sub>2</sub> emissions originate from this industry in EU-27 [5], which generated 252.5 million tonnes of CO<sub>2</sub> emissions on average during the period 2005 to 2008 [6]. Given the importance of this industrial sector, several studies have addressed CO<sub>2</sub> emission and energy efficiency issues for different regions of the world, mainly looking at their potential reduction and improvement options respectively [7- 21]. Nevertheless, none of these studies have analysed the role of technology innovation and its diffusion in the environmental and energy efficiency performance of the sector from the point of view of the cost-effectiveness of the retrofits of the main process at the plant level and, in particular, for the EU-27 Iron & Steel industry in the medium-to-long term.

The model presented in this document to achieve the above mentioned objective is an extension of the model developed by TNO and Tata Steel under the contract "IE/2009/07/06/OC NL-Petten: Energy Efficiency and CO<sub>2</sub> Emissions Prospective Scenarios for the Iron and Steel Industry in the EU". This bottom-up model at facility level of the European Iron & Steel industry models the cost-effectiveness of the market roll-out of the main technologies or processes within each facility. In order to prepare the scenarios analysed and a potential evolution of the sector up to 2030, this document describes energy consumption, emissions of CO<sub>2</sub> in the processes, iron & steel production, scrap availability and economic cost, together with retrofitting options and potential innovation in each European iron & steel plant.

Three different scenarios have been defined for this study: a baseline scenario (BS) and two alternative scenarios (AS1 and AS2). The BS studies the evolution of the iron & steel industry assuming that the current trends in iron & steel demand and production, scrap availability, energy prices and CO<sub>2</sub> emission prices are followed [22]. The alternative scenarios (AS1 and AS2) examine the influence of the variation of fuel and resource prices and CO<sub>2</sub> emission prices on the energy efficiency performance of the iron & steel industry.

Section 2 describes the current state of art of the European iron & steel industry. Section 3 presents the current, best and innovative technologies in the iron & steel industry. Section 4 summarises the methodology used to evaluate the European iron & steel industry. Section 5 presents and analyses the main results. Finally, Section 6 summarizes the main conclusions of the work.

## 2. Background of the iron & steel industry in the EU-27

Iron ore is the basic raw material used in the iron & steel industry. It is one of the most common materials found on earth and is mined in open pit mines and transferred by sea and rail to iron and steel plants in several parts of the world.

Due to its characteristics and its wide versatility, steel plays an essential role in our everyday life. It has applications in the construction of buildings, bridges, roads and railways, the manufacture of vehicles, energy-producing technologies, means of transferring energy, and also in the manufacture of food containers and beverages.

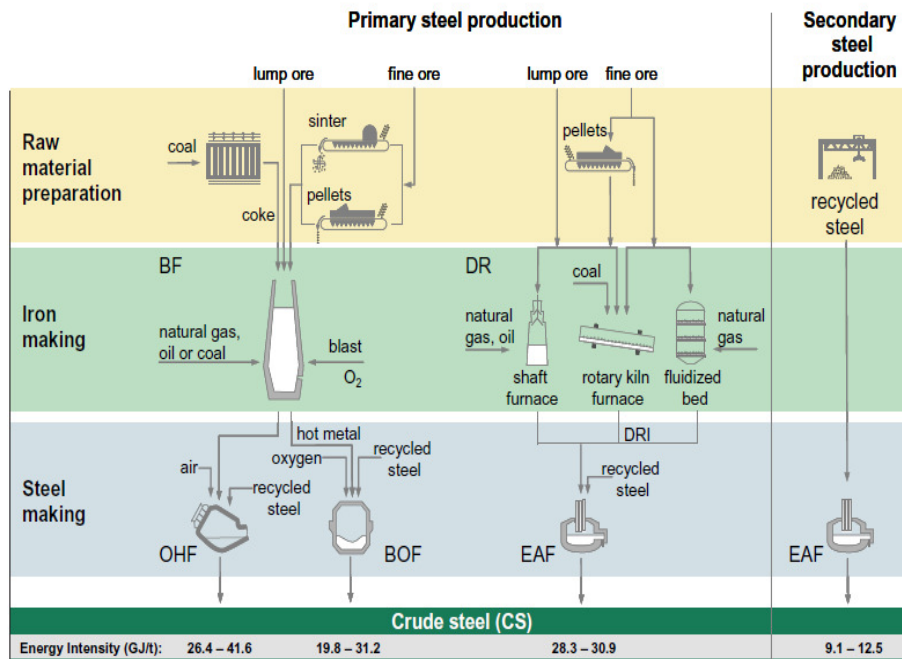
This chapter presents the current state of the art of the iron and steel industry in the EU27, including the main routes used for iron & steel production, together with the current view of the production and consumption of iron & steel in the context of the EU-27.

### 2.1. Production routes in EU-27

In the iron and steel industry a limited number of processes are used for the manufacture of steel [23]. Figure 1 presents an overview of the main processes. The primary steel production route, also referred to as the integrated steel production route, and the secondary steel production route essentially consist of three basic steps: raw material preparation, iron making and steel making.

A typical integrated steelmaking plant consists of a coke oven, a sinter plant, a blast furnace and either a basic oxygen furnace (BOF), which is also called basic oxygen steel (BOS) plant, or an open hearth furnace (OHF). The blast furnace is fed with iron ore, coke and preheated air to produce pig iron (hot metal). The pig iron is then refined in a blast furnace or an open hearth furnace to obtain the crude steel. The energy intensity of the primary steel production route, using the basic oxygen furnace, varies between 17 and 23 GJ per tonne of crude steel with an average value of 21GJ per tonne of steel in the EU [24]. This variation is influenced by/depends on the iron ore and coal quality, the steel grade and the material efficiency. The open hearth furnace route is more capital intensive and less productive. Currently, only a very small capacity is still in use in the EU due to the replacement of this technology by BOF technology at the end of the last century [25]. The secondary steel production route does not require a coke or a sinter plant because the recycled steel scrap is melted directly in an electric arc furnace (EAF). The energy intensity of this route ranges from 9.1 to 12.5 GJ per tonne of steel [24].





**Figure 1: Primary and secondary steel production routes [26]**

Another way to produce crude steel is by directly reducing iron ore (DRI) in a shaft furnace producing sponge iron [27]. The sponge iron and steel scrap is then melted in an electric arc furnace in order to obtain crude steel. The average energy intensity is typically between 28.3 and 30.9 GJ per tonne of steel. This technology is mostly in use in countries with an abundance of natural gas, and is not common in Europe.

Lastly, Table 1 shows the share of Iron & Steel production in EU in 2008. This was 58% from basic oxygen furnaces, 41.4% from the secondary steel production using electric arc furnaces and 0.3% from the open hearth furnace route [28]. In Europe, only Germany and Sweden produced steel directly by the reducing iron ore process (DRI process) with a total amount of 520 kilo-tonnes and 120 kilo-tonnes respectively [28].

**Table 1: Capacity share of the different crude steel production routes in the EU-27 countries in 2008, [28].**

	BOF, %	EAF, %	OHF, %
Austria	90.5	9.5	0.0
Belgium	69.4	30.6	0.0
Finland	71.3	28.7	0.0
France	59.7	40.3	0.0
Germany	68.1	31.9	0.0
Greece	0.0	100.0	0.0
Italy	35.7	64.3	0.0
Luxembourg	0.0	100.0	0.0
Netherlands	97.8	2.2	0.0
Portugal	0.0	100.0	0.0
Spain	21.8	78.2	0.0
Sweden	66.2	33.8	0.0
United Kingdom	77.5	22.8	0.0
Bulgaria	32.2	67.8	0.0
Czech Republic	90.1	9.9	0.0
Hungary	75.0	25.0	0.0
Latvia	0.0	0.3	99.7

Poland	53.7	46.3	0.0
Romania	66.4	33.6	0.0
Slovakia	91.5	8.5	0.0
Slovenia	0.0	100.0	0.0
EU27	58.2	41.4	0.3

## 2.2. Steel consumption in EU-27

The EU-27 was responsible for 23% of global steel consumption in 1998, whereas in 2008 its share in consumption had dropped to 16% due to the increase in the demand for steel in the developing countries (i.e. China, India, and Russia) [28].

Apparent crude steel consumption<sup>1</sup> in the EU-27 increased at an average rate of 2% in the period of 2000-2008, but it fell drastically in 2009 by around 30% due to the current financial crisis. Figure 2 shows the apparent crude steel consumption per country in the EU-27 in 2008, where Germany, Italy and Spain are the main steel consumers with around half of the EU-27 steel consumption [28].

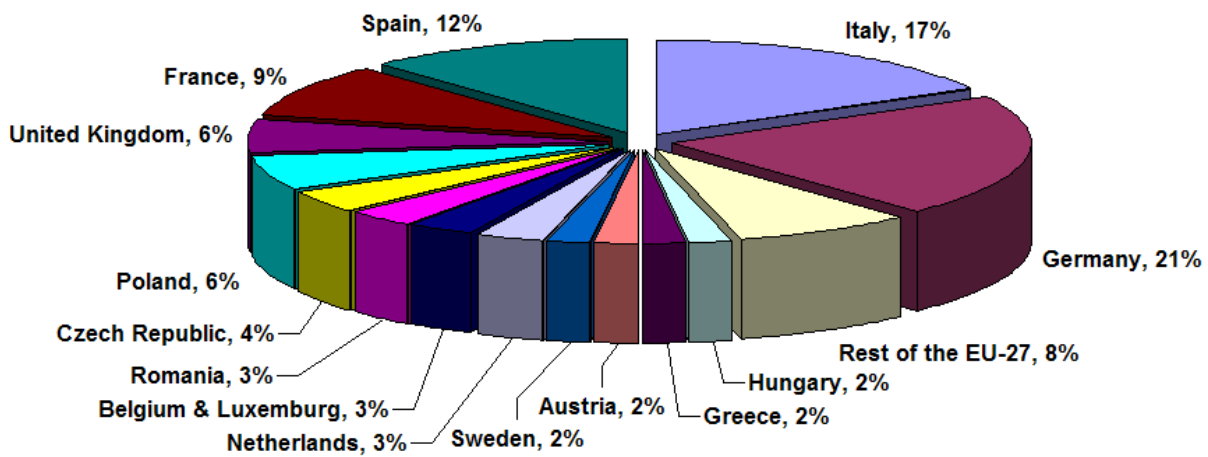


Figure 2: Apparent crude steel consumption per country in 2008

Steel has many applications in a variety of sectors. The major steel consuming sectors in the EU-27 are construction, the automotive sector and mechanical engineering, which account for more than 50% of total steel consumption, as reflected in Figure 3 [29].

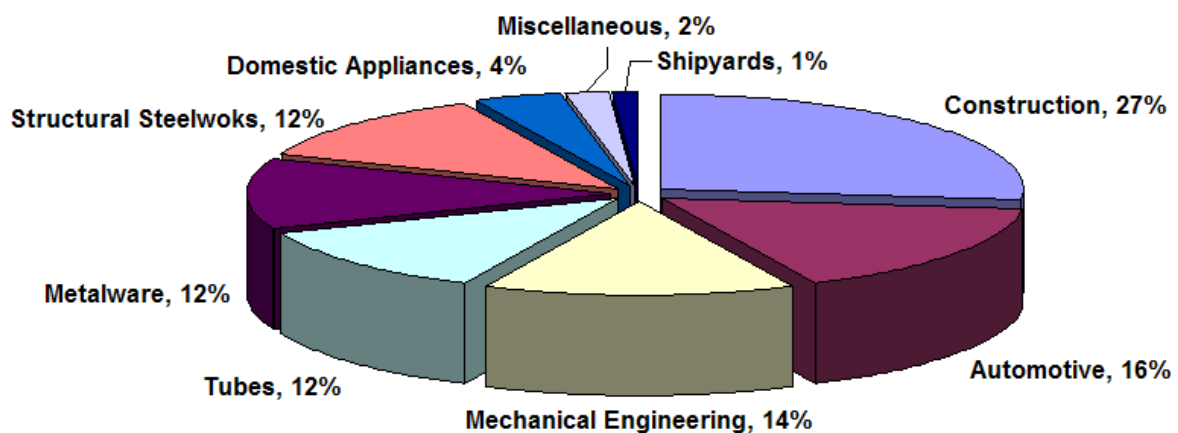


Figure 3: Steel consumption by sectors.

<sup>1</sup> Apparent steel consumption is the steel production minus imports and exports.

### 2.3. Steel production in EU-27

The production of crude steel in the EU in 2008 was 198 Mt, representing 14.9% of the total world production (1327 million tonnes of crude steel) [29]. Ten years earlier, with a slightly lower production (191Mt of crude steel), the same European countries accounted for a 24.6% share. The main difference is that the Chinese production grew more than fourfold over this period (from 114 Mt to 500 Mt of crude steel) [29]. In 2009, with the financial crisis, the production level in Europe dropped by around 30% compared to the previous three years. Despite this situation, the growth in the production of iron & steel in the EU27 is expected to be 1.18% per year up to 2030, together with a stable production for the integrated route 22. This would amount to a production of around 260 Mt of crude steel in 2030.

Iron ore production is highly concentrated in certain countries, with the most significant iron ore reserves being in Brazil and Australia. This lack of local raw materials in EU27 results in the increasing capacity share of the secondary steel production route, but this share is limited by the availability of scrap.

Figure 4 shows the crude steel production in the EU-27: the major steel producing countries are Germany, Italy, Spain and France, which account for more than 55% of the EU-27 steel production. As far as the position of the European steel companies in the world ranking is concerned, the world's largest producer was the European company ArcelorMittal, the second largest European producer (the eighth world producer) was Tata steel, and the third European producer was Riva in sixteenth position in the world and ThyssenKrupp and Techint (the fourth and fifth European steel companies) were the world's 18th and 27th biggest producers respectively [29].

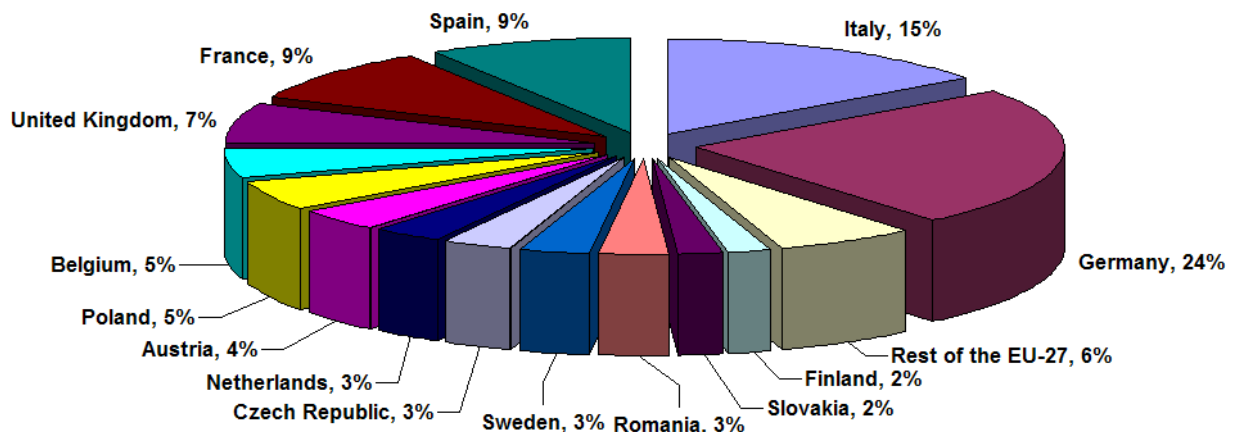


Figure 4: Crude steel production in the EU-27, in 2008

### 3. Iron & Steel Production - Current, Best and Innovative Technologies

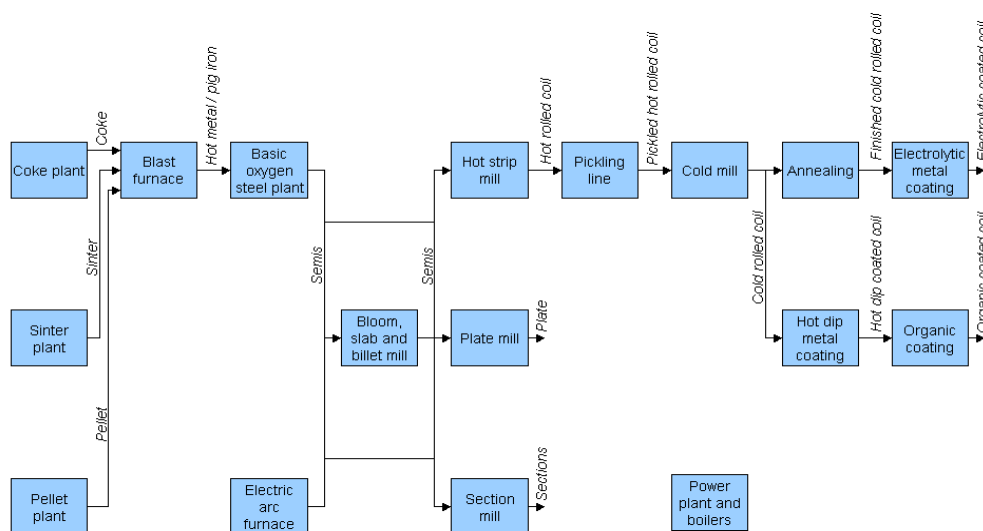
This chapter describes the current pathway for Iron & Steel production, including the energy consumption and CO<sub>2</sub> emissions of each process which takes place in the Iron & Steel plants in the EU27. It goes on to describe the Best Available Technologies (BATs). In the present work it is considered that BATs have to be a deployed technology which can be applied in multiple plants and enables a significant reduction in energy and CO<sub>2</sub> emissions. Finally, the Innovative Technologies (ITs) are described. These technologies can be divided into two types: industrial innovative technologies which have been demonstrated already on an industrial scale, but whose use are not widespread in the European Iron & Steel sector and, second, the most promising technologies for the medium term, which are currently under development.

### 3.1. Steel production in EU-27 – Current Technology

Figure 5 presents the pathways currently used for steel production in Europe. Liquid steel is made either through the blast furnace or the electric arc furnace route. In the blast furnace route, iron ore is agglomerated to obtain sinter or pellets. These agglomerates are charged together with coke and coal into a blast furnace, which produces hot metal. Most of the carbon in hot metal is removed in a basic oxygen steel (BOS) plant, which results in liquid steel. In the electric arc furnace route, liquid steel is produced from recycled scrap in an electric arc furnace (EAF). The liquid steel obtained through both routes is cast into semis and further processed in mills.

The cast semis can be reshaped in a bloom, slab or billet mill. However, in most cases, the semis are processed directly in hot strip mills, plate mills and section mills. The oxide layer on the strip surface can be removed in a pickle line. After pickling, the strip gauge can be reduced in a cold mill. Cold rolled strip acquires the desired mechanical properties by batch or continuous annealing, which also takes place in a hot dip metal coating line. After annealing, the strip can be coated with another metal, using either an electrolytic or a hot dip process. Finally, the hot dipped strip is coated with paint by an organic coating line.

Most sites with blast furnace route have boilers and a power plant onsite or near to the site to generate steam and electricity. These installations are mainly fired by gaseous fuels that are released in coke plants (coke oven gas), blast furnaces (blast furnace gas) and BOS plants (BOS gas).



**Figure 5: Current pathways for Iron & Steel production in Europe**

Table 2 shows the estimated specific energy consumption and specific CO<sub>2</sub> emissions per tonne of product of the different elements which configure the current pathway for steel production in Europe. The negative values in the primary and direct energy consumption in the BOS plant are due to the fact that BOS gas is formed by the reaction of the injected oxygen in the BOS plant with the carbon contained in pig iron coming from the Blast Furnace Plant. This means that the process is creating more energy resources than it is consuming.

**Table 2: Estimated specific energy consumption and specific CO<sub>2</sub> emissions per tonne of product of the current pathways for the Iron & Steel production in Europe.**

	Primary energy <sup>2</sup> (GJ/t)	Direct energy <sup>3</sup> (GJ/t)	Total CO <sub>2</sub> emission <sup>4</sup> (tCO <sub>2</sub> /t)	Direct CO <sub>2</sub> emission <sup>5</sup> (tCO <sub>2</sub> /t)
Coke plant	6.827	6.539	0.824	0.794
Sinter plant	1.730	1.549	0.211	0.200
Pellet plant	1.204	0.901	0.075	0.057
Blast furnace	12.989	12.309	1.279	1.219
BOS plant	-0.253	-0.853	0.202	0.181
Electric arc furnace	6.181	2.505	0.240	0.240
Bloom, slab and billet mill	2.501	1.783	0.125	0.088
Hot strip mill	2.411	1.700	0.120	0.082
Plate Mill	2.642	1.905	0.133	0.098
Section Mill	2.544	1.828	0.127	0.084
Pickling line	0.338	0.222	0.016	0.004
Cold mill	1.727	0.743	0.075	0.008
Annealing	1.356	1.086	0.070	0.049
Hot dip metal coating	2.108	1.491	0.104	0.059
Electrolytic metal coating	4.469	2.619	0.208	0.046
Organic coating	1.594	0.758	0.074	0.003
Power Plant	12.173	12.173	1.989	1.989

There are alternative processes for producing iron & steel, apart from the process described above. Nevertheless, the steel production capacity from these plants accounts for only a small share in the EU27. There are only two open hearth furnaces, which are currently responsible for 1.6% of the total production capacity. There are two plants based on direct smelting or reduction plants to produce directly reduced iron (DRI), which represent 0.5% of the total production capacity. Finally, the plants which employ induction melt and steel re-melting furnaces contribute only 0.2% of the total production capacity, and these are used to produce special grades of steel.

The information on iron & steel plants in the EU27 is extracted from the VDEh Plantfacts database, based on the update of 17 December 2009 [30]. This database contains information and data for each facility, such as the year of construction and modernization, manufacturer and operating status and details of the design, processes and dimensions, materials processed products, plant capacity and technologies implemented.

Owing to the lack of information in the database, the following simplifications have been adopted: i) AC and DC electric arc furnaces are treated as one facility type, ii) Ladle furnaces, special converter processes and casters are treated as parts of BOS plants or electric arc furnaces, iii) Blooming and slabbing mills and billet mills are treated as one facility type, iv) Heavy section, medium section, light section and bar mills are treated as one facility type, v) Batch and continuous annealing are treated as one facility type, and vi) The information about boilers and power plants is added from the Plant Electric Power database, [31], as this information is not contained in the Plantfacts database [30].

Finally, 1 590 processes are obtained based on the VDEh Plantfacts database [30]. Table 3 shows the number of these facilities according to current pathways for European iron & steel production.

<sup>2</sup> Primary energy: Actual energy content (lower heating value) together with the upstream energy used to produce a material (e.g. energy to produce the electricity).

<sup>3</sup> Direct energy: energy use of a specific installation only.

<sup>4</sup> Total CO<sub>2</sub> emission: Direct CO<sub>2</sub> emission to air due to use of a material together with the upstream emissions (emitted by suppliers) of a limited list of materials

<sup>5</sup> Direct CO<sub>2</sub> emission: Only CO<sub>2</sub> emission to air of a specific installation

**Table 3: Processes identified in the Iron & Steel industry in EU-27**

Coke plants	62	Plate mills	41
Sinter plants	50	Section mills	206
Pellet plants	7	Pickling lines	145
Blast furnaces	88	Cold mills	222
Basic oxygen steel plants	41	Annealing plants	173
Electric arc furnaces	232	Hot dip metal coating lines	107
Bloom, slab and billet mills	52	Electrolytic metal coating lines	55
Hot strip mills	48	Organic coating lines	61

### 3.2. Best Available Technologies (BATs)

Best Available Technologies (BATs) are different technologies which can be applied in the different processes which configure the current Iron & Steel pathways in order to improve their performance. In the present work, it is considered that a BAT has to be a deployed technology which can be applied in multiple plants and enables a significant reduction in the energy and CO<sub>2</sub> emissions to be achieved.

Table 4 lists an overview of the possible BATs available for the Iron & Steel industry according to the criteria set out in the previous paragraph. This table also indicates the type and the area where a BAT can be implemented. The present work is focused on the BATs for processes up to the production of semis (coke plant, sinter plant, pellet plant, blast furnace, BOF, electric arc furnace and bloom slab and billet mill) and only on the ‘add on’ or ‘process intensification’ types, omitting all other BATs that have different implementation methods, such as ‘new technologies’, which require the replacement of complete plants, and ‘process control’ and ‘maintenance’, due to the fact that this information is confidential at plant level.

**Table 4: Overview of the possible BATs in the Iron & Steel industry<sup>6</sup>.**

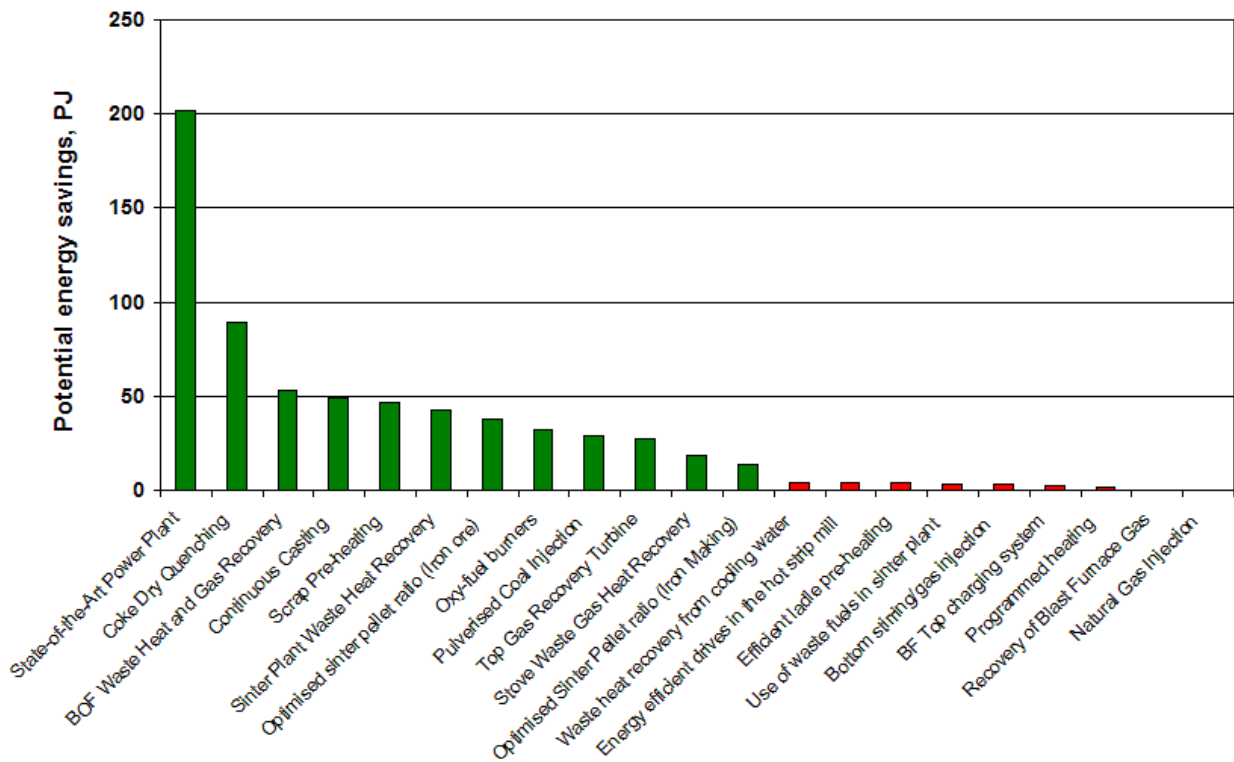
AREA	Best Available Technologies for Iron and Steel Industry	Type
General *	State-of-the-Art Power Plant	Add on <sup>7</sup>
General	Energy monitoring and management system	Process Control
General	Variable speed drive: flue gas control, pumps, fans	Process Control
General	Preventative maintenance	Maintenance
Coke making *	Coke Dry Quenching	Add on
Coke making *	Programmed heating	Add on
Coke making *	Coal moisture control	Add on
Coke making	Variable speed drive coke oven gas compressors	Process Control
Iron ore preparation *	Sinter Plant Waste Heat Recovery	Add on
Iron ore preparation *	Use of waste fuels in sinter plant	Process Intensification
Iron ore preparation	Reduction of air leakage	Process Control
Iron ore preparation	Increased bed depth	Process Control
Iron ore preparation	Improved process control	Process Control
Sinter Plant *	Optimised sinter pellet ratio	Process Intensification
Iron Making *	Top Gas Recovery Turbine	Add on
Iron Making *	Stove Waste Gas Heat Recovery	Add on
Iron Making *	BF Top Charging System	Add on
Iron Making *	Recovery of Blast Furnace Gas	Add on
Iron Making *	Optimised Sinter Pellet ratio	Process Intensification

<sup>6</sup> The technologies, which this work focuses on, are identified by \*

<sup>7</sup> The term ‘Add on’ refers to the cases where the BAT is a physical element that can be added to the plant

Iron Making *	Pulverised Coal Injection	Process Intensification
Iron Making *	Natural Gas Injection	Process Intensification
Iron Making	Improved blast furnace control	Process Control
Steel making *	BOF Waste Heat and Gas Recovery	Add on
Steel making EAF *	Scrap Pre-heating	Add on
Steel making EAF *	Oxy-fuel burners	Add on
Steel making EAF *	Bottom stirring/gas injection	Add on
Steel making EAF	Foamy slag practices	Process Control
Steel making EAF	Improved process control	Process Control
Steel making EAF	Eccentric bottom tapping	New technology
Steel making EAF	Twin shell furnace	New technology
Steel making EAF	Direct Current (DC) arc furnace	New technology
Hot Rolling	Waste heat recovery from cooling water	Add on
Hot Rolling	Energy efficient drives in the hot strip mill	Add on
Hot Rolling	Insulation of furnaces	Add on
Hot Rolling	Process control in hot strip mill	Process Control
Hot Rolling	Recuperative burners in the reheating furnace	New technology
Hot Rolling	Hot charging	New technology
Cold Rolling	Reduced steam use in the pickling line	Add on
Cold Rolling	Waste Heat Recovery on the annealing line	Add on
Cold Rolling	Automatic monitoring and targeting system	Process Control
Integrated Casting	Efficient ladle pre-heating	Add on
Integrated Casting	Continuous Casting	Process Control
Integrated Casting	Direct Sheet Plant	New technology

The BATs selected in Table 4 have a different relevance in the context of the European Iron & Steel industry. The selection of the most relevant BATs considered in this work is based on the energy saving potential of each specific BAT. This potential is a measure of the total energy savings when a specific BAT is installed at all possible facilities in the EU. Figure 6 shows the ranking of the potential energy savings for the BATs. The cut-off point to include a BAT in the model is established in 5 PJ of potential energy saving. This means that the first BAT which passes the cut-off is the Optimised Sinter Pellet ratio (iron making) with a potential energy saving of 14PJ.



**Figure 6: Ranking of the potential energy savings for BATs considered in this work**

The following paragraphs present the description, energy consumption and CO<sub>2</sub> emissions for each selected BATs.

**State-of-the-art Power Plant:** European integrated steel sites in Europe usually have a power plant on site or near the site where process related gases, such as blast furnace gas, BOF gas and coke oven gas are used to produce power and steam. Most power plants operating on steel plant gases have a boiler in combination with a steam turbine, which provides the necessary flexibility to operate on the different types of gas produced in the steel. The total average efficiency for the conversion from steel plant gases to electricity is currently 32% [32]. This current average efficiency of power and steam production is below the best practice, and the aim of this BAT is to increase the efficiency of energy conversion by replacing older installations with new state-of-the-art steam boiler and turbine technologies. No state-of-the-art Power and Steam Production is currently installed in the EU [30].

**Coke Dry Quenching (CDQ):** At the end of the coke production process, hot coke is pushed out of the coke oven. Traditionally, large volumes of water are used to cool the hot coke directly in a wet quenching system. The water partly evaporates in a cooling tower, and this heat is lost to the atmosphere. CDQ cools the coke by circulating a non-active gas (nitrogen) in the cooling chamber. Then, the energy recovered by this gas is used to generate high pressure steam, which can be used to produce electricity or for other purposes. This technology also has the added advantage that it uses less water. Five CDQs are currently installed in the EU [30].

**BOF Waste Heat and Gas Recovery:** In Basic Oxygen Furnace (BOF) steelmaking, a charge of molten iron and scrap steel along with some other additives (manganese and fluxes) is heated and refined to produce crude steel. An oxygen lance is lowered into the converter and pure oxygen is blown into the furnace. The carbon in the steel reacts to CO and CO<sub>2</sub> and leaves the converter as gas. Two systems can be used to recover energy from the converter gas. In the first one, BOF gas is combusted in the converter gas duct, and subsequently the sensible heat is recovered in a waste heat boiler. In the second system, BOF gas is cleaned, cooled and stored in a gas holder for further use. Twenty two BOF Waste Heat and Gas Recovery system are currently installed in the EU [30].



**Continuous Casting:** Today continuous casting is the preferred choice in new steelmaking plants instead of ingot casting. In ingot casting molten steel is poured into large rectangular molds. After solidification of steel, the ingot molds are mechanically removed and placed in tightly covered soaking pits. The ingots are then rolled to the desired shape in a primary rolling mill. Continuous casting replaces the primary rolling process, including re-heating by casting the slabs, blooms or billets directly to the right shape for hot rolling. Continuous casting reduces the energy needs for the primary rolling and, even more importantly, reduces material losses. The increased yield comes from reducing scrap production in the manufacturing process. End losses are eliminated and oxidation losses are reduced due to reduced exposure of the hot steel to the air. No Continuous Casting systems are currently installed in the EU [30].

**Scrap Pre-heating:** The growth of steel production by Electric Arc Furnace (EAF) in Western countries is stimulated by the higher operational flexibility it provides in comparison with the Blast Furnace route. Still, some 20% of all the energy input for melting the scrap in an EAF disappears in the form of waste gas. Preheating of scrap is a technology that can reduce the power consumption in the EAF process by using the waste heat of the furnace to preheat the incoming scrap charge [33]. There are ninety-nine Scrap Pre-heating systems currently installed in the EU [30].

**Sinter Plant Waste Gas Heat Recovery:** Sintered ore from the sinter plant is used as raw material in the blast furnace. Sintered ore is produced from fine iron ore, coke and limestone at very high temperatures. The sinter feed is deposited as a bed, and the coke in the upper layer is ignited. As the sinter bed moves forward, air is drawn through the bed to maintain combustion of the coke. Generally two systems can be used to recover energy from the sintering process. In the first of these, the exhaust gas from the sinter bed can be returned to the sinter bed as combustion air. This system can be applied to reduce energy consumption by economising on coke use. In the second one, energy from the hot sintered ore is recovered at the end of the sinter bed, using a sintered ore cooling system. The hot air can be applied to generate steam. There are 12 Sinter Plant Waste Gas Heat Recovery systems currently installed in the EU [30].

**Optimized Sinter Pellet Ratio:** Iron ore is mainly fed into a Blast Furnace in the form of sinter and pellet. The ore is agglomerated before charging the Blast Furnace in order to create enough permeability in the Blast Furnace, so that the reduction gases can flow up through the layers of sinter, pellet and coke. The CO<sub>2</sub> emissions related to pellet production are lower than for sinter production. However, only very few Blast Furnaces in Europe operate on high pellet concentration. By far the majority of Blast Furnaces operate with more sinter than pellet input. The aim of this BAT is to achieve a sinter-pellet ratio of at least 50/50 for each Blast Furnace, in order to reduce CO<sub>2</sub> emissions and increase energy savings. The Optimized Sinter Pellet Ratio concept is not currently implemented in any iron & steel plants in the EU [30].

**Oxy-fuel Burners:** In an Electric Arc Furnace (EAF) high intensity electric energy is passed between electrodes to create an arc that melts steel scrap. The use of EAF's allows steel to be made from 100% scrap metal feedstock. Modern furnaces use oxygen-fuel burners to provide chemical energy to the cold-spots, making the heating of the steel more uniform. Oxy-fuel burners reduce electricity consumption by substituting electricity with fuels and increase heat transfer. Some 136 Oxy-fuel Burners are currently installed in the EU [30].

**Pulverised Coal Injection (PCI):** The main benefit for the injection of coal in a blast furnace is cost savings by lower coke rates. Cost of coke is substantially higher than that of coal. The estimated economic impact on blast furnace operation is mainly determined by the coke replacement ratio, which indicates the kilograms of coke replaced per kilogram of coal injected. It is not the replacement of the coke by pulverised coal injection, but rather the coke making process, that saves energy in the blast furnace itself. No PCIs are currently installed in the EU [30].

**Top Gas Recovery Turbine (TRT):** The top gas from the Blast Furnace has an over-pressure which can be utilized to produce additional electricity with a TRT. The current practice in the industry uses a pressure valve to reduce the top gas pressure. In this way, the pressure energy of the gas is converted

to noise and this energy is wasted. Although the over-pressure is low, the presence of large gas volumes makes the energy recovery economically still feasible. There are 22 TRTs currently installed in the EU [30].

**Stove Waste Gas Heat Recovery:** A Waste Gas Heat Recovery System (WGHR) improves the efficiency of the Hot Blast Stoves as the (thermal) heat from the waste gas of the Hot Blast Stoves is partially recovered by external (mechanical) heat exchangers. The recovered heat is typically used to pre-heat the BF-gas and/or combustion air. The main advantage of pre-heating BF-gas/air is the fact that the enrichment gas consumption is reduced or eliminated. Where more low quality BF-gas can be used as a replacement for the higher quality and more costly enrichment gas, overall savings can be made. Eighteen Stove Waste Gas Heat Recoveries are currently installed in the EU [30].

Table 5 shows the estimated specific reduction in the energy consumption and specific CO<sub>2</sub> emissions per tonne of product of the selected BATs related with their process. As an example, the Coke Dry Quenching produces a reduction in the direct emission in the Coke Oven Plant of 0.010 tonnes of CO<sub>2</sub> per tonne of coke [34].

**Table 5: Estimated reduction in specific energy consumption and specific CO<sub>2</sub> emission (per tonne of its corresponding product) of the BAT technologies**

	Primary energy (GJ/t)	Direct energy (GJ/t)	Total CO <sub>2</sub> emission (tCO <sub>2</sub> /t)	Direct CO <sub>2</sub> emission (tCO <sub>2</sub> /t)
State-of-the-Art Power Plant	-2.830	-2.830	-0.442	-0.442
Coke Dry Quenching	-1.605	-1.463	-0.083	-0.010
BOF Waste Heat and Gas Recovery	-0.916	-0.908	-0.051	-0.040
Continuous Casting	-2.436	-1.727	-0.122	-0.085
Scrap Pre-heating	-0.900	-0.288	-0.037	-0.037
Sinter Plant Waste Heat Recovery	-0.402	-0.387	-0.027	-0.012
Optimized Sinter Pellet ratio – Iron Ore	-0.420	-0.359	-0.035	-0.032
Oxy-fuel burners	-0.215	0.013	-0.006	-0.009
Pulverised Coal Injection	0.203	0.126	-0.021	-0.026
Top Gas Recovery Turbine	-0.338	-0.108	-0.014	0.000
Stove Waste Gas Heat Recovery	-0.160	-0.160	-0.015	-0.015
Optimized Sinter Pellet ratio – Iron Making	0.000	0.000	0.000	0.000

### 3.3. Innovative Technologies (ITs)

For the purposes of the present work, two types of Innovative Technologies (ITs) are considered: first, the industrial innovative technologies which have already been demonstrated on industrial scale, but not yet implemented or well established in Europe and, second, the most promising technologies in the short and medium term, which are currently under development basically under the ULCOS<sup>8</sup> program [35].

Although the industrial innovative technologies can be categorized as a BAT, it was preferred to categorize them as innovative technologies due to the large size of these projects and the associated high investment costs. The selection of these technologies is based on their potential for energy saving and reduction of CO<sub>2</sub> emissions in Europe up to 2030. **This group includes Corex/Finex ironmaking, MIDREX, Energinon/HYL, Direct Sheet Plant (DSP) and Carbon Capture and Storage**

<sup>8</sup> ULCOS: Ultra-Low CO<sub>2</sub> Steelmaking project [35].

**(CCS).** Corex operates in South Africa, India, China and Korea. Finex has been installed at POSCO, Korea. European DSP's are operated in the Netherlands, Germany, Italy and Turkey. Although CCS is not yet demonstrated on an industrial scale, its application in the decarbonization of the steel sector is very promising. In addition, MIDREX and EnergIron/HYL have a presence in the Middle East due to the high natural gas reserves in this area.

ULCOS is a consortium of 48 European companies and organizations from 15 European countries which have launched a cooperative research and development initiative to enable a drastic reduction in the CO<sub>2</sub> emissions from steel production. The aim of the ULCOS program is to reduce the CO<sub>2</sub> emissions of today's best routes by at least 50%. The program's main focus is to integrate steel plant process technology improvements and alternatives using iron ore, although one sub-programme is currently focusing on electrolysis [36, 37]. Four breakthrough technologies have been identified under the ULCOS program: **Top Gas Recycling Blast Furnace, Hisarna, ULCORED and ULCOWIN.**

**Corex:** In this process, lump iron ore and/or pellets and additives are loaded into the top of a reduction shaft. Reducing gas from the melter-gasifier is injected into the lower part to reduce the iron ore to sponge iron. The additives ensure an adequate slag basicity, and sulphur is removed from the hot metal in the melter-gasifier. The hot direct reduced iron and calcined additives are then transferred into the melter-gasifier. The top gas leaving from the shaft is cooled and cleaned in a scrubber. Part of this gas is recycled, while the remainder, known as export gas, is sold. The top gas can only be partly recycled, because it is necessary to add 'fresh' oxygen and coal in order to generate heat.

**Finex:** In this process, fine iron ore is charged in a series of fluidized-bed reactors. As it passes downwards, it is heated and reduced to obtain direct reduced iron by means of the upward flowing reduction gas, produced by the melter-gasifier. The direct reduced iron fines are then compacted to obtain hot-compacted iron and loaded into the melter-gasifier by gravity.

**Direct Sheet Plant (DSP):** the full integration of casting and rolling process is achieved by a direct sheet plant, without the need for intermediate inspection or handling of the slabs, which avoids having to cool down the slabs for transport. In addition, it does away with the need for a hot strip mill reheating furnace. Instead, a tunnel or roller hearth furnace may be required for monitoring of the sheet temperature, but this consumes significantly less gas than a conventional reheating furnace.

**Carbon Capture and Storage (CCS, expected year 2020):** CCS is a key element for the decarbonization of the Iron & Steel industry. In an integrated steel plant there are basically two issues due to the fact that they concentrate CO<sub>2</sub> emissions for the application of this technology: namely the blast furnaces and the power plants that are usually linked to the Iron & Steel plant. There are three main techniques for the separation of CO<sub>2</sub>. Post-combustion capture is based on the separation of CO<sub>2</sub> after combustion. This means that the challenge is to separate CO<sub>2</sub> from the exhaust gases by means of an absorption liquid which captures the CO<sub>2</sub>; this CO<sub>2</sub> can then be transported to its place of storage. Pre-combustion capture is based on the separation of CO<sub>2</sub> before combustion. Typically, the fuel is gasified, which gives syn-gas. This syn-gas can be converted to H<sub>2</sub> and CO<sub>2</sub> using a water gas shift reaction. CO<sub>2</sub> is then removed from this stream by means of an absorption liquid, and subsequently transported and stored. The hydrogen can be combusted for energy production. Oxy-fuel combustion is based on the use of pure oxygen instead of air, ensuring that the flue gases will contain predominantly CO<sub>2</sub>, which can be directly transported and stored.

**ULCORED (expected year 2020), Midrex and HYL:** ULCORED, Midrex and HYL are three processes that produce direct reduced iron from pellets by gas-based direct reduction in a shaft furnace. The three processes are very similar, although they differ in terms of the details of how the gas is produced and heat is recovered. The gas used for reduction can be either natural gas or coke oven gas. Alternatively, the gas can be made by gasifying coal or biomass. The decision between using gas or resorting to gasification will depend on local availability and the price of the resources. When these technologies are based on a coal gasifier they contain a CO<sub>2</sub> removal step. This means that these options are easy to combine with CCS, subject to minimal additional investment. A purification step might still be necessary, according to the necessary specifications for storage. ULCORED is a process

that was developed within the ULCOS consortium, and is not yet in operation. Midrex and HYL are both readily available and operated at several locations.

**Top Gas Recycle Blast Furnace (expected year 2020):** This technology relies on the removal of CO<sub>2</sub> from the top gas of the Blast Furnace, thereby recovering useful components such as CO and H<sub>2</sub>. Re-injection of CO and H<sub>2</sub> gases allows coke rates to be reduced. To facilitate the removal of CO<sub>2</sub>, the system is operated on pure oxygen instead of hot blast.

**Hlsarna (expected year 2030):** This technology is based on bath-smelting. It combines preheating of coal and partial pyrolysis in a reactor, a melting cyclone for ore melting and a smelter vessel for final ore reduction and iron production. It requires significantly less coal to reduce the CO<sub>2</sub> emissions. Moreover, it is a flexible process that allows to be partially substituted by biomass, natural gas or even hydrogen.

**ULCOWIN (expected year 2040):** This process produces direct reduced iron from iron ore by means of alkaline electrolysis. The reduction of the iron oxide into iron takes place at the cathode (positively charged). Oxide donates electrons at the anode (negatively charged), with the formation of oxygen. This process has been demonstrated at the laboratory scale. Nevertheless, a scaled-up solution is not readily available, and additional research is required.

Table 6 shows the estimated reduction in energy consumption and CO<sub>2</sub> emissions per tonne of product of the selected ITs in its own IT. As an example, the ULCORED process produces a reduction of the direct emission in the Iron & Steel primary production route of 0.915 tonnes of CO<sub>2</sub> per tonne of steel [34]. Note that a technology can produce a reduction in CO<sub>2</sub> emissions at the same time as it produces an increase in energy consumption (e.g. Finex). Due to its long term expectation, ULCOWIN technology it is not quantified.

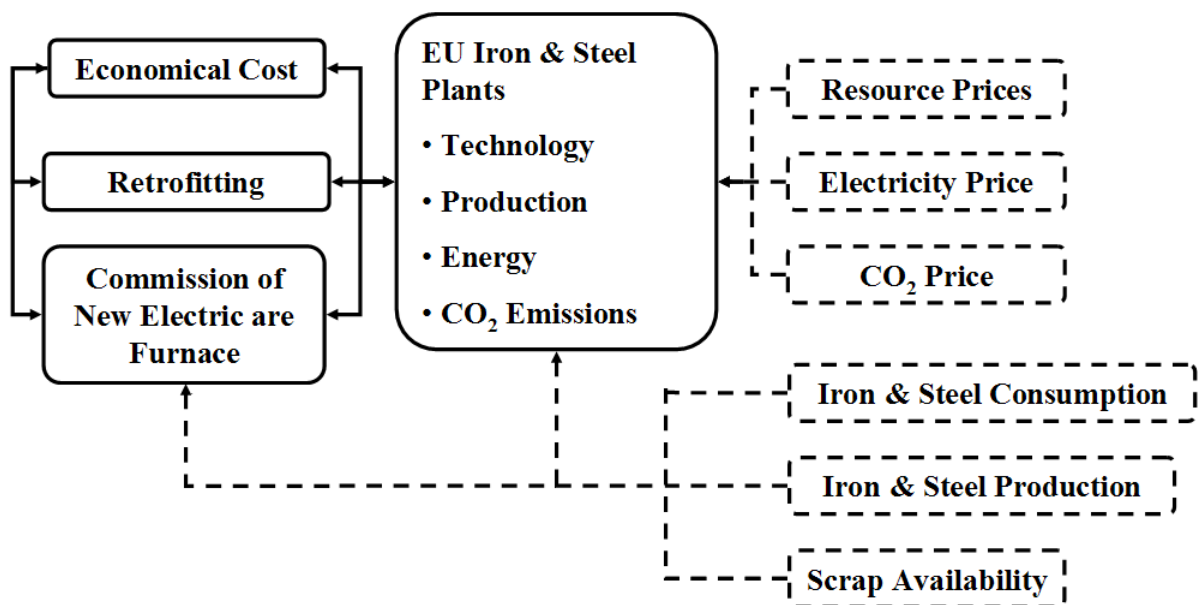
**Table 6: Estimated reduction in specific energy consumption and specific CO<sub>2</sub> emissions (per tonne of its corresponding product) of the IT technologies<sup>9</sup>**

	Primary energy (GJ/t)	Direct energy (GJ/t)	Total CO <sub>2</sub> emission (tCO <sub>2</sub> /t)	Direct CO <sub>2</sub> emission (tCO <sub>2</sub> /t)
Corex	3.210	0.306	1.364	1.243
Finex	7.499	4.445	-0.814	-0.948
Direct Sheet Plant	-1.375	-1.185	-0.073	-0.068
CCS – Blast Furnace	2.340	0.749	0.097	0.000
CCS – Power Plant	0.574	0.184	0.024	0.000
Midrex	1.510	-1.474	-1.046	-0.997
HYL	1.815	-0.862	-1.020	-0.951
ULCORED	1.614	-2.474	-0.907	-0.915
Top Gas Recycle Blast Furnace	-0.364	-1.226	-0.325	-0.347
HISARNA	0.613	-1.562	-0.383	-0.462

<sup>9</sup> Notice this values can have certain uncertainty due to the lack of current information for the IT technologies

## 4. Methodology and Model

This chapter presents the methodology and the model developed to study the prospects for energy efficiency and CO<sub>2</sub> emissions, together with the incorporation of BATs and ITs in the European Iron & Steel up to 2030. A bottom-up model has been developed at the facility level of the European Iron & Steel industry in order to achieve this objective. Figure 7 represents a schematic overview of the Iron & Steel model. The dotted boxes denote the exogenous variables linked to the model. Every year during the simulation period, energy consumption and CO<sub>2</sub> emissions in each European Iron & Steel plant are calculated taking into account its iron & steel production, technology and resources. Iron & steel plants are able to retrofit their equipment incorporating BATs and ITs, in order to improve energy efficiency and reduce CO<sub>2</sub> emissions in a cost effective way according to an economic criterion. The model also considers the possibility of commissioning a New EAF according to the economic conditions and scrap availability. The various aspects of this diagram are shown in more detail in the subsections of this chapter.



**Figure 7: Schematic overview of the Iron & Steel model**

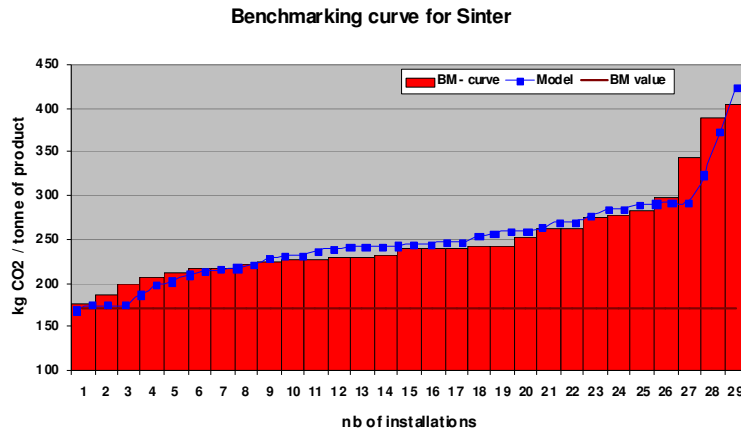
Finally, the following subsections present the various features of the model, namely calibration of the model, Iron & Steel production and demand projections, new EAF plant description, retrofitting options, Iron & Steel production costs and the scenarios developed in this study.

### 4.1. Calibration of the model

The VDEh Plantfacts database contains no information about resources, energy consumption and CO<sub>2</sub> emissions at facility level, because that information is confidential. This means that, in the model, all the iron & steel plants with the same technologies have the same specific energy consumption and CO<sub>2</sub> emissions. However, benchmarking curves for the CO<sub>2</sub> emissions devised by the European Commission [38] show that no two facilities are similar. This information at facility level is used to modify the initial values of specific energy consumption and CO<sub>2</sub> emissions in a manner that resembles the actual benchmarking curves, referred to as the calibration of the first year of the simulation. The calibrated specific CO<sub>2</sub> emission for each plant is estimated by the following equation:

$$CO_{2,p,c} = (Cap_p/Cap_{ref})^n CO_{2,p,o} \quad (1)$$

where  $CO_{2,p,c}$  is the calibrated specific CO<sub>2</sub> emission of the plant,  $CO_{2,p,o}$  is the original specific CO<sub>2</sub> emission of the plant before the calibration,  $Cap_p$  is the capacity of the plant,  $Cap_{ref}$  is the reference capacity of the plants and  $n$  is the scale coefficient.  $Cap_{ref}$  and  $n$  are used to fit the benchmarking curves of the model to the European Commission's benchmarking curve. Figure 8 shows the benchmarking curves of the model and the original ones from the European Commission.



**Figure 8: Adjustment of the benchmarking curves of the model to the real ones**

With this calibration, each facility of the model is assigned one of the actual CO<sub>2</sub> emissions recorded by the industry in 2010. This calibration enables the model to use CO<sub>2</sub> emission values that are quite close to the real ones. Although there is small error in the adjustment (the determination coefficients obtained were 0.97 and higher), using this approach, the specific CO<sub>2</sub> emissions is one of the parameters in the model which, despite the confidentiality surrounding these matters, is optimally adjusted. Subsequently, the greatest uncertainty in the input parameters lies in the values corresponding to emission and consumption of the ITs, and to the capital costs of all BATs and ITs in general.

## 4.2. Iron & steel production and demand projections

The model considers that, between 2009 and 2030, the finished steel consumption is expected to grow by a Compound Annual Growth Rate (CAGR) of 2% per year for the EU-27. This means that, following the collapse of the iron & steel market in 2009, the EU market will have to make a structural downward adjustment, and EU steel demand will still be 8% lower in 2030 compared to 2007. The growth rate for EU-15 and for the new Member States is estimated at 1.0% and 2.1% respectively between 2012 and 2030, giving an average growth rate of 1.2% per year for the EU-27 during this period [39].

An annual growth of 1.8% for the EU-27 between 2009 and 2030 is expected for finished steel production. Therefore, EU steel production will still be 4.5% lower in 2030 than in 2007. The growth rate for EU15 and for the new Member States between 2012 and 2030 is estimated at 1.0% [22, 39].

Consistent with long-term trends, the model assumes that EU steel exports will decline in future, from traditionally being a net exporter to becoming self-sufficient in steel by 2030. This means that steel production in the EU will grow less than steel consumption [22, 39].

Finally, Figure 9 shows the estimated projections for the iron & steel production and demand including net exports for the EU27 up to 2030.

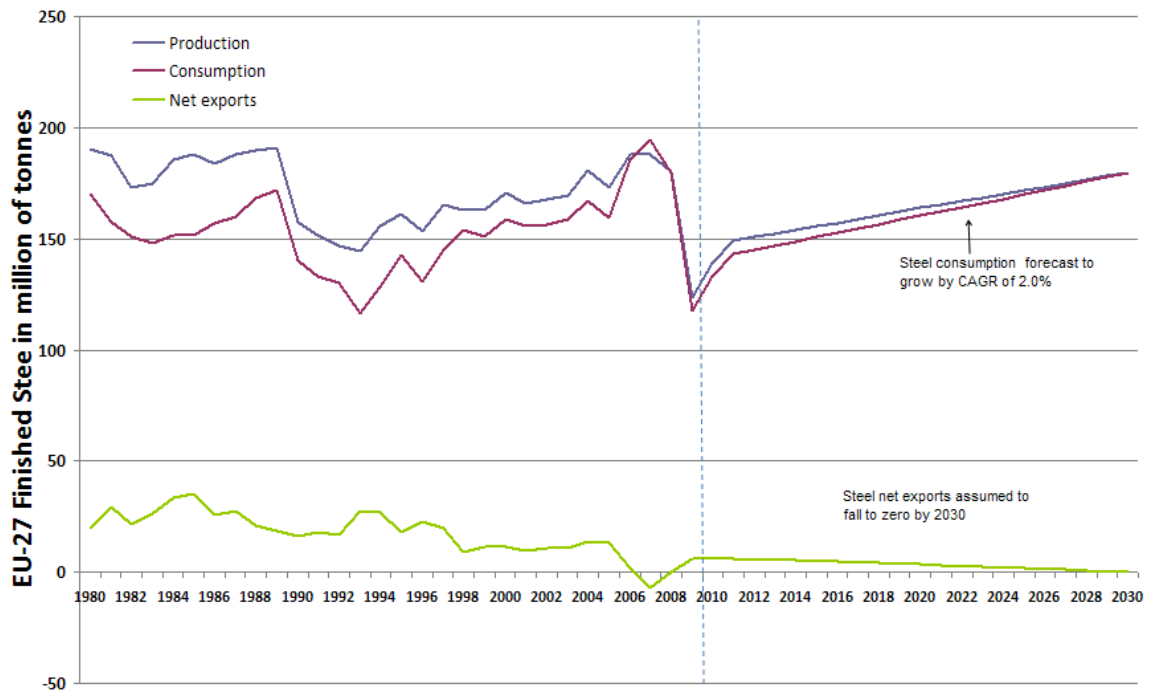
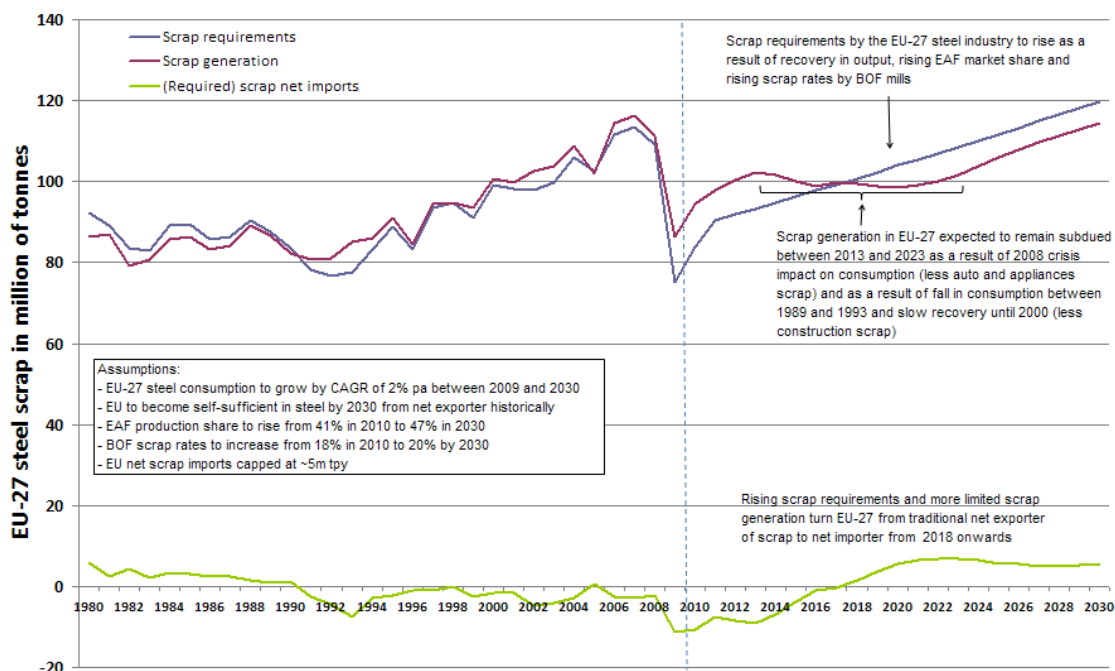


Figure 9: Iron & Steel production, demand and net export for EU27 up to 2030

### 4.3. Scrap availability

Scrap is a highly valuable raw material, which competes with hot metal and virgin metal (which are produced from mined ore) as a raw material for steelmaking. Integrated and EAF mills have some flexibility when it comes to substituting scrap for other metal input (hot metal, pig iron and DRI). Consequently, scrap markets tend to follow developments in the markets for steel and raw materials, and scrap prices normally follow the trends of finished steel prices, as well as those for iron ore and coal. An important characteristic of scrap is that, due to its flexibility in terms of supply and use, it can be considered as what can “make the difference” for the iron & steel industry. Increasing or decreasing use of the scrap is one important way to adapt the steel production to the demand in the short term.

There are three main sources of ferrous scrap: *home scrap*, which is waste material generated within the steel mill, for example steel left in the slag, skulls that emerge during casting, damaged coils or sheet, coil head and tail parts and side trimmings, *prompt scrap*, which is the waste material generated by the industrial user of steel, for example construction companies, shipbuilders and industrial manufacturers (OEMs) of steel consuming products, and *obsolete scrap* which is the largest source of scrap and consists of steel material that is recycled after the end of life of products containing steel.



**Figure 10: Scrap requirements, scrap generation and scrap net import for the EU27**

Figure 10 shows the expected scrap requirements, scrap generation and scrap net import for the EU-27 up to 2030. The model assumes that the scrap requirements will increase in the EU Iron & Steel industry up to 2030, driven by the anticipated increase in the demand for steel, the rise in the BOF scrap rate from its current level of 18% to 20% in 2030, and the increase in the share of the EAF iron & steel market, which uses 100% scrap, from the current 41% to 47% in 2030. At the same time, availability of home and prompt scrap is expected to post a modest (relative) decrease in the future on the back of continuing improvements in yield losses by steel mills and manufacturers of steel containing products. The recovery of obsolete scrap is expected to fall and remain relatively low between 2013 and 2023, due to the impact of the 2009 crisis on future availability of scrap from cars, appliances and other consumer goods (5-7 years time-lag) and the impact of the sharp fall in steel consumption between 1989-1993, and the subsequent slow recovery until 2000, which affects the availability of scrap from construction between 2013 and 2023 (25-30 year time-lag). This situation is likely to increase the pressure on the scrap supply/demand balance in the EU in the future, with the EU steel industry requiring an additional ~30 million tonnes of scrap per year in total by 2030 from 2009 onwards. However scrap recovery rates are also expected to rise from their current 50% to 58% in 2030, which will provide an additional 14 million tonnes or so of scrap per year. The remaining shortage has to be covered by imports in line with the current historical balance for net scrap import in the EU [40].

#### 4.4. Description of the new EAF plant

The model adds new installations when the production rises above the installed capacity. Only the new EAF plants are added by the model. The new EAF plants have a better performance in terms of energy consumption and CO<sub>2</sub> emissions than the current EAF. There is also the fact that New EAF have implemented scrap pre-heating and oxy-fuel burners. Table 7 shows specific energy consumption and CO<sub>2</sub> emissions. The installed capacity of each unit is defined in the model for a production of 800 kilotonnes of steel per year. The model avoids building new EAF plants if the availability of scrap in the EU is insufficient to cover the needs of the plant.



**Table 7: Estimated specific energy consumption and specific CO<sub>2</sub> emissions per tonne of product of New EAF**

	Primary energy (GJ/t)	Direct energy (GJ/t)	Total CO <sub>2</sub> emission (tCO <sub>2</sub> /t)	Direct CO <sub>2</sub> emission (tCO <sub>2</sub> /t)
New EAF	4.368	1.819	0.175	0.140

#### 4.5. Retrofitting options: implementation of BATs and ITs

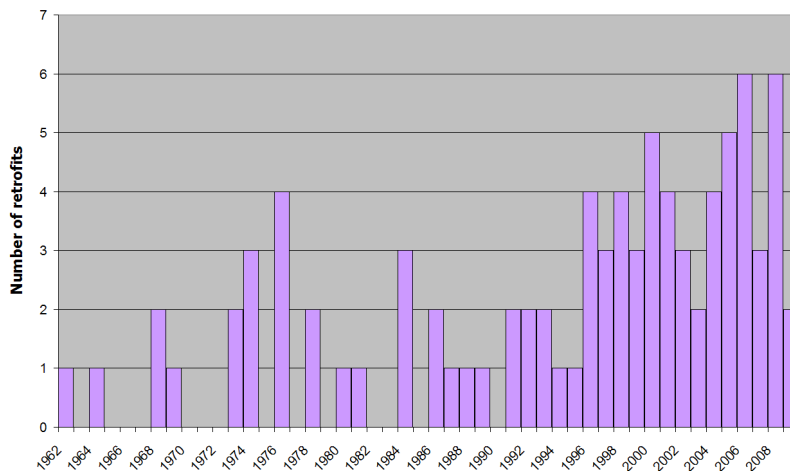
Each year, a cost-benefit analysis of all possible BATs and ITs is calculated for each facility. The criterion used as a basis for accepting or rejecting different investments is the payback period (set at two years in the model [41]). When there are a number of investments meeting this criterion, the model chooses the BAT or IT with the lowest payback period.

The formula used to calculate the payback period is:

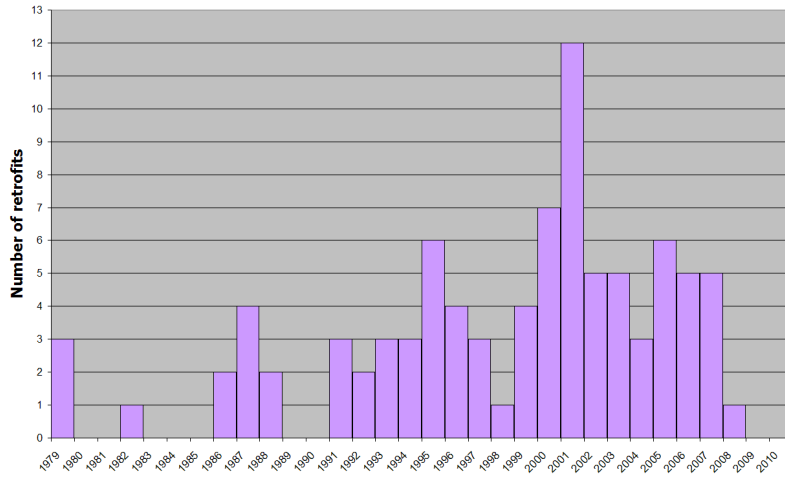
$$PayBackPeriod = \frac{INV_{Retro}}{COP_{Before Retro} - COP_{After Retro}} \quad (2)$$

Where,  $INV_{Retro}$  is the total investment cost of retrofitting,  $COP_{Before Retro}$  is the annual operational cost (O&M, fuels, materials, CO<sub>2</sub> cost ...) before retrofitting, and  $COP_{After Retro}$  is the annual operational cost (O&M, fuels, materials, CO<sub>2</sub> cost ...) after retrofitting.

It is assumed that there will be no more than six retrofits for the integrated and secondary steel route per year. The values for the maximum number of simultaneous retrofits have been derived from the historical information obtained from the database of the Iron & Steel industry of EU27 [30]. Figure 11 and Figure 12 show the histogram of the historical number of major retrofits (incorporation of BATs or ITs) in the EU integrated and secondary steel routes.



**Figure 11: Historical number of major retrofits in the EU integrated steel route**



**Figure 12: Historical number of mayor retrofits in the EU integrated steel route**

The purpose of introducing this constraint is to consider the overall effect of barriers in the industry. Under current conditions, not all investments are undertaken only when they become cost effective. This is what is widely referred to as the ‘energy efficiency gap’. By limiting the annual rate of changes in the industry to historical records only, we have attempted to simulate the likely performance of the industry. The possible retrofitting of the power plant or the implementation of CCS in the power plants are included in this constraint. The reason for this is that it is assumed that, when a power plant associated to an iron and steel facility and the own iron and steel facility belong to the same company, the financial requirements for this investment compete with the needs of other BATs or ITs of the facility.

In the model the main difference in the treatment between BATs and ITs is the year in which those technologies are available. Meanwhile, BATs are available from the first year of the simulation, the ITs can be installed according to the estimated year when these technologies are likely to be commercially available [42].

The capital cost of a new BAT or IT is estimated by the following equation [43]:

$$Inv_{BAT,IT} = \left( \frac{C}{C_{ref}} \right)^n \cdot Inv_{ref} \quad (2)$$

where  $Inv_{BAT,IT}$  is the investment cost of the BAT or IT to be installed,  $C$  is the capacity of the BAT or IT,  $C_{ref}$  is the capacity of the reference BAT or IT,  $n$  is the scale coefficient, which is considered to be 0.6 and  $Inv_{ref}$  is the reference investment cost of the BAT or IT technologies [44]. Table 8 shows the reference capacities, the estimated investment cost for each BAT or IT<sup>10</sup> [45-51] and the availability date that the model uses for those technologies. The investment cost for the Optimized Sinter Pellet ratio for Iron Ore and Iron Making is considered to be zero, because this BAT is related to the improvement of the operation of the plant and not to the installation of new equipment.

<sup>10</sup> Notice this values can have certain uncertainty due to the lack of current information for the IT technologies

**Table 8: Reference capacities and investment cost for each BAT and IT and expected availability date**

	Reference Capacity		Reference Investment Cost		Availability date
State-of-the-Art Power Plant	100	MWe	70	M€	2010
Coke Dry Quenching	1.5	Mt/year	69	M€	2010
BOF Waste Heat and Gas Recovery	2.8	Mt/year	37.5	M€	2010
Continuous Casting	1	Mt/year	80	M€	2010
Scrap Pre-heating	0.5	Mt/year	2.3	M€	2010
Sinter Plant Waste Heat Recovery	1.8	Mt/year	6	M€	2010
Optimized Sinter Pellet ratio – Iron Ore	0	Mt/year	0	M€	2010
Oxy-fuel burners	0.5	Mt/year	2.8	M€	2010
Pulverised Coal Injection	10	Mt/year	57	M€	2010
Top Gas Recovery Turbine	3	Mt/year	9	M€	2010
Stove Waste Gas Heat Recovery	1.5	Mt/year	3.7	M€	2010
Optimized Sinter Pellet ratio – Iron Making	0	Mt/year	0	M€	2010
Corex	2	Mt/year	460	M€	2010
Finex	2	Mt/year	460	M€	2010
Direct Sheet Plant	2	Mt/year	250	M€	2010
CCS – Blast Furnace	1	Mt/year	107	M€	2020
CCS – Power Plant	400	MWe	345	M€	2020
Midrex	1	Mt/year	250	M€	2010
HYL	2	Mt/year	350	M€	2010
ULCORED	1	Mt/year	250	M€	2020
Top Gas Recycle Blast Furnace	2	Mt/year	100	M€	2020
HISARNA	1	Mt/year	100	M€	2030

It should be noted that most of the ITs are mutually exclusive because they completely replace existing facilities within a plant. Therefore, the model avoids the installation of incompatible ITs in the same iron & steel plant. For the particular case of CCS technology the capture efficiency is considered to be 85%. Nevertheless, the efficiency in the capture of the CO<sub>2</sub> is assumed to be 100% if the CCS plant is combined with an IT which generates almost a pure CO<sub>2</sub> stream, i.e. Top Gas Recycling and ULCORED. The Hisarna technology generates a gas stream with 85% of CO<sub>2</sub>, which also can be stored directly with a corresponding penalty due to the higher volume of gas [52, 53].

#### 4.6. Iron & steel production costs

In the model, the iron & steel production cost is calculated in each plant every year. The total cost is broken down into four parts: energy and resource cost, CO<sub>2</sub> emission allowance cost, transport cost and other costs, which include costs such as labour and maintenance.

**Energy and resource costs:** Table 9 shows energy and resource costs for the production of the Iron & Steel estimated for the simulation. These prices are based on the current prices in 2010, plus annual growth rates up to 2030 [54-56]. The annual growth rates for electricity, natural gas, coal and oxygen

follow the trends given by the European Commission [22]. For the other resources an annual growth rate of 1.2% is assumed in the absence of any other information.

**Table 9: Energy and resources prices for 2010 and annual growth up 2030 (n.a.: not applicable)**

	Price 2010	Annual growth rate
Electricity	70 €/MWh	0.81%
Natural gas	219 €/km <sup>3</sup>	1.98%
Oxygen	93 €/kNm <sup>3</sup>	1.00%
Steam <sup>11</sup>	0 €/t	n.a.
Coke	376 €/t	1.20%
Pellet	133 €/t	1.20%
Coal	170 €/t	1.64%
Iron ore	106 €/t	1.20%
Scrap	255 €/t	1.20%
Limestone	20 €/t	1.20%
Burnt lime	100 €/t	1.20%
Tar	175 €/t	1.20%
EAF slag	8 €/t	1.20%
BOS slag	8 €/t	1.20%
Granulated BF slag	8 €/t	1.20%

**CO<sub>2</sub> emission allowance cost:** The European Iron & Steel industry is one of the sectors at risk of ‘carbon leakage’. This means a possible loss of competitiveness compared to countries where there is weaker regulation of emissions [57]. To avoid this situation, the European Commission allocates free CO<sub>2</sub> emission allowances under a specific benchmark for this industry. This benchmark is set by the average CO<sub>2</sub> emission intensity of 10% of the best performing plants. The remaining CO<sub>2</sub> emissions have to be purchased under the European Emission Trading System [58]. In the model it is considered that the CO<sub>2</sub> emission prices have risen during the simulation period from 11 €/tonne of CO<sub>2</sub> in 2010, 25 €/tonne of CO<sub>2</sub> in 2020 to 39 €/tonne of CO<sub>2</sub> in 2030 [22].

**Other costs:** These costs are specifically related to the different processes of each facility, such as desulphurization, consumables, alloys, CO<sub>2</sub> transport and storage, electrodes, labour and maintenance (L&M), etc. Table 10 shows these costs for each facility for 2010, including their estimated annual growth rate up to 2030 [52, 53]. In addition, labour and maintenance costs are weighted according to the country in which the facility is located[59].

**Table 10: Other cost prices for 2010 and annual growth up 2030**

	Price 2010	Annual growth rate
Coke plant (incl. L&M)	21 €/t	1.20%
Sinter plant (incl. L&M)	4 €/t	1.20%
Pellet plant (incl. L&M)	0 €/t	1.20%
Blast furnace (incl. L&M)	14 €/t	1.20%
BOS plant (incl. L&M)	25 €/t	1.20%
Electric arc furnace (incl. L&M)	37 €/t	1.20%
Bloom, slab and billet mill (incl. L&M)	8 €/t	1.20%
Hot strip mill (incl. L&M)	16 €/t	1.20%
Power Plant (incl. L&M)	4 €/MWh	1.20%
CO <sub>2</sub> transport and storage - CCS	5 €/tCO <sub>2</sub>	1.20%

<sup>11</sup> The price of the steam is considered zero because in a Iron & Steel plant is possible to generated steam from the waste heat due to the high temperatures reached in the Iron & Steel processes.

## 4.7. Scenarios

Three different scenarios are considered: a baseline scenario (BS) and two alternative scenarios (AS1 and AS2). The main objective of the two alternative scenarios is to check the sensitivity of the BS scenarios using different values of some of the main drivers of technology deployment.

The BS scenario studies the evolution of the Iron and Steel industry according to the projections given in [22] in production and demand, scrap availability and energy and CO<sub>2</sub> prices. The AS1 scenario analyses the influence of the increase in fuel prices in the Iron & Steel industry. In this scenario, two cases are studied: a doubling of the final price of the BS scenario in 2030 (case 2x-Fuel) and a fivefold increase compared to the BS scenario in 2030 (case 5x-Fuel). Lastly, the AS2 scenario examines the behaviour of the iron and steel industry with respect to variations in the emission price of CO<sub>2</sub>. In this scenario two cases are analysed: a final CO<sub>2</sub> price of 100€ per tonne of CO<sub>2</sub> in 2030 (Case 100€-CO<sub>2</sub>) and a final price of 200€ per tonne of CO<sub>2</sub> in 2030 (Case 200€-CO<sub>2</sub>). The values used for the final prices of CO<sub>2</sub> allowances and the factor applied to the projection of prices of fuels and resources serve to check the ability of those drivers to bring about technological improvements in the industry.

The FINEX/COREX technologies were initially excluded from the discussion about their effect in the scenarios. Although the industry admits that these technologies can be used in Europe in the future if there is a need for increments in the production of the integrated route, their ability to replace current facilities lacks credibility [24]. However, the consequences of their inclusion are discussed briefly in point 5.4.

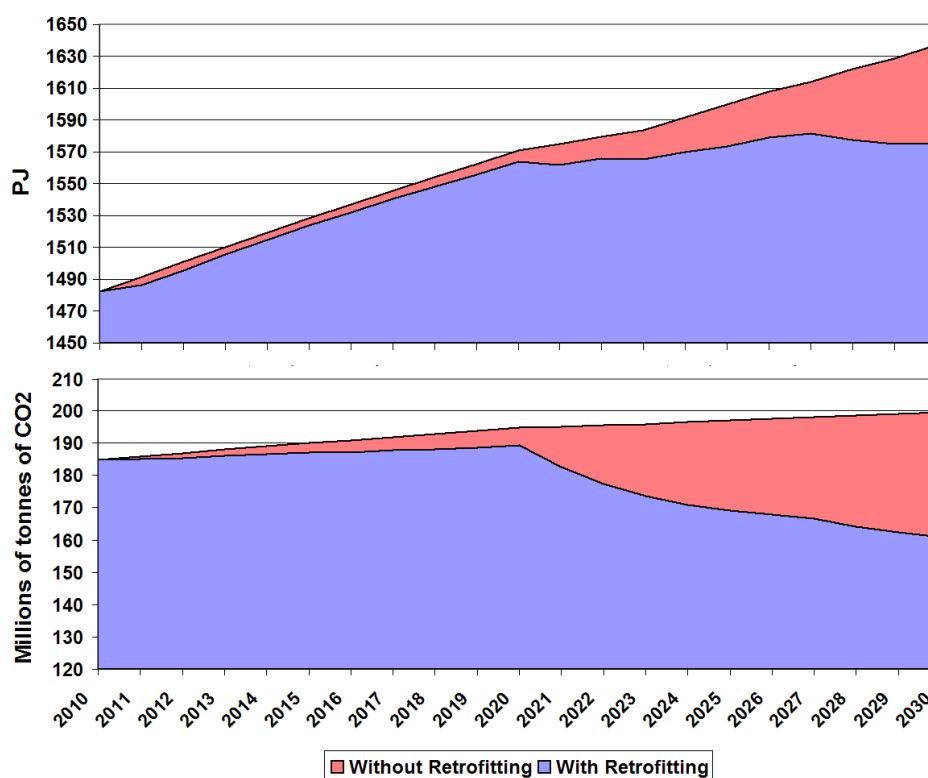
## 5. Simulation results

This section presents the trend in the EU-27 Iron & Steel industry for the Baseline scenario and Alternative scenarios AS1 and AS2 up to 2030. The impact of the incorporation of the BATs and ITs technologies according to the main constraints of each scenario is studied, together with their effect on direct specific energy consumption and CO<sub>2</sub> emissions.

### 5.1. Baseline scenario - BS

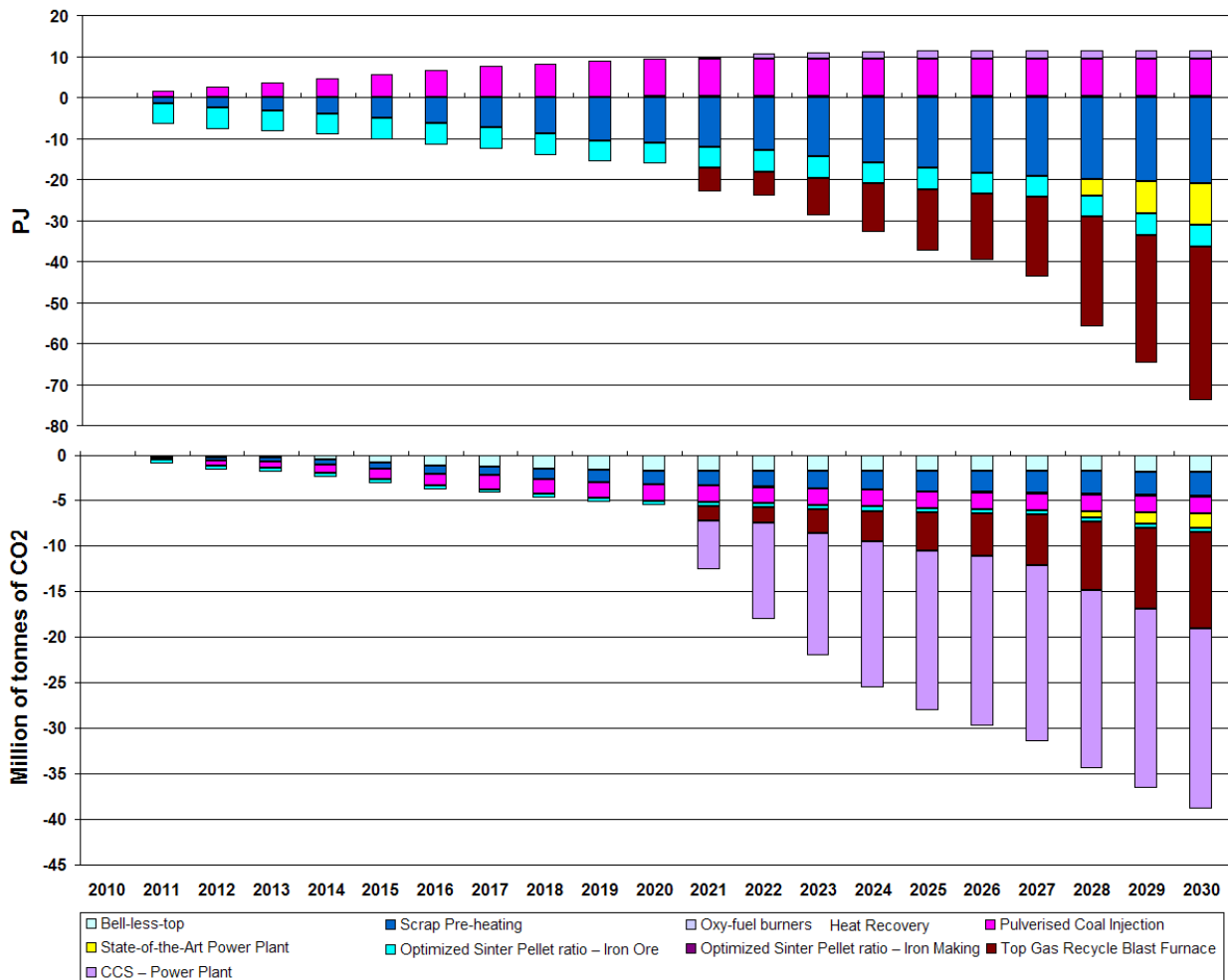
The BS scenario studies the trend in the energy consumption and CO<sub>2</sub> emissions of the iron and steel industry, assuming that the estimated projection in production and demand, scrap availability and energy, resource and CO<sub>2</sub> prices is adhered to.

Figure 13 shows the trends for the total direct energy consumption and the total direct CO<sub>2</sub> emissions on the EU-27 Iron & Steel industry and power plants associated with iron and steel facilities under the BS scenario, whether or not retrofits are allowed. The contribution of energy consumed and CO<sub>2</sub> emissions by power plants to the total reflected in the upper areas of Figure 13 (without retrofits) are 91 PJ and 23 MtCO<sub>2</sub>, respectively. The difference between the two curves highlights the importance of the effect of the incorporation of the BATs and ITs technologies in reducing energy consumption and CO<sub>2</sub> emissions in this sector. The savings in CO<sub>2</sub> emissions amount to 38 MtCO<sub>2</sub> (45% in the indigenous iron and steel industry and 55% in associated power plants). The savings in energy consumption amount to 55 PJ (87% of it in the iron and steel industry and 13% in associated power plants). Two periods displaying differing trends in energy consumption and CO<sub>2</sub> emissions can be identified in this figure: they are characterised by the periods from 2010 to 2020 and from 2021 to 2030. During the first period, only BATs are incorporated in the iron & steel plants. The reason is that these IT technologies, which could represent breakthroughs in terms of improving the performance of the sector, are either not available on the market or not economically feasible. As a consequence, between now and 2022 there will be only a slight reduction in overall total direct energy consumption and CO<sub>2</sub> emissions of 0.5% and 2.8%, respectively. It is in that second period, when IT technologies are becoming available, that there is likely to be a major reduction of 10.4% in energy consumption and of 22.3% in total direct CO<sub>2</sub> emissions between the two cases in 2030.



**Figure 13: Total direct energy consumption and total direct CO<sub>2</sub> emissions on EU-27 Iron & Steel Industry, and associated power plants, under the BS scenario up to 2030, whether retrofits are allowed or not.**

Figure 14 represents the variation in the total direct energy consumption and the total direct CO<sub>2</sub> emissions by technology following the simulation under the BS scenario. In this scenario, nine technologies are deemed the most suitable to be incorporated by the Iron & Steel industry and associated power plants. Seven of these technologies are BATs. The Scrap Pre-heating technology incorporated in the EAF has the greatest impact in terms of reducing the energy consumption, and this technology, together with the Pulverised Coal Injection technology, is the most suitable way to lower CO<sub>2</sub> emissions. In addition, in spite of the late incorporation of State-of-the-Art Power Plants, the impact of this technology on total direct CO<sub>2</sub> emissions will reach a relatively high share in 2030. The upper figure shows a small increase in energy consumption. This is linked to the sizeable drop in CO<sub>2</sub> emissions from power plants. Nevertheless, the biggest improvement in performance will come from the incorporation of IT technologies from 2021 onwards. The impact of ITs will account for 56.7% and 78.1% of the energy and CO<sub>2</sub> emissions savings respectively in 2030.



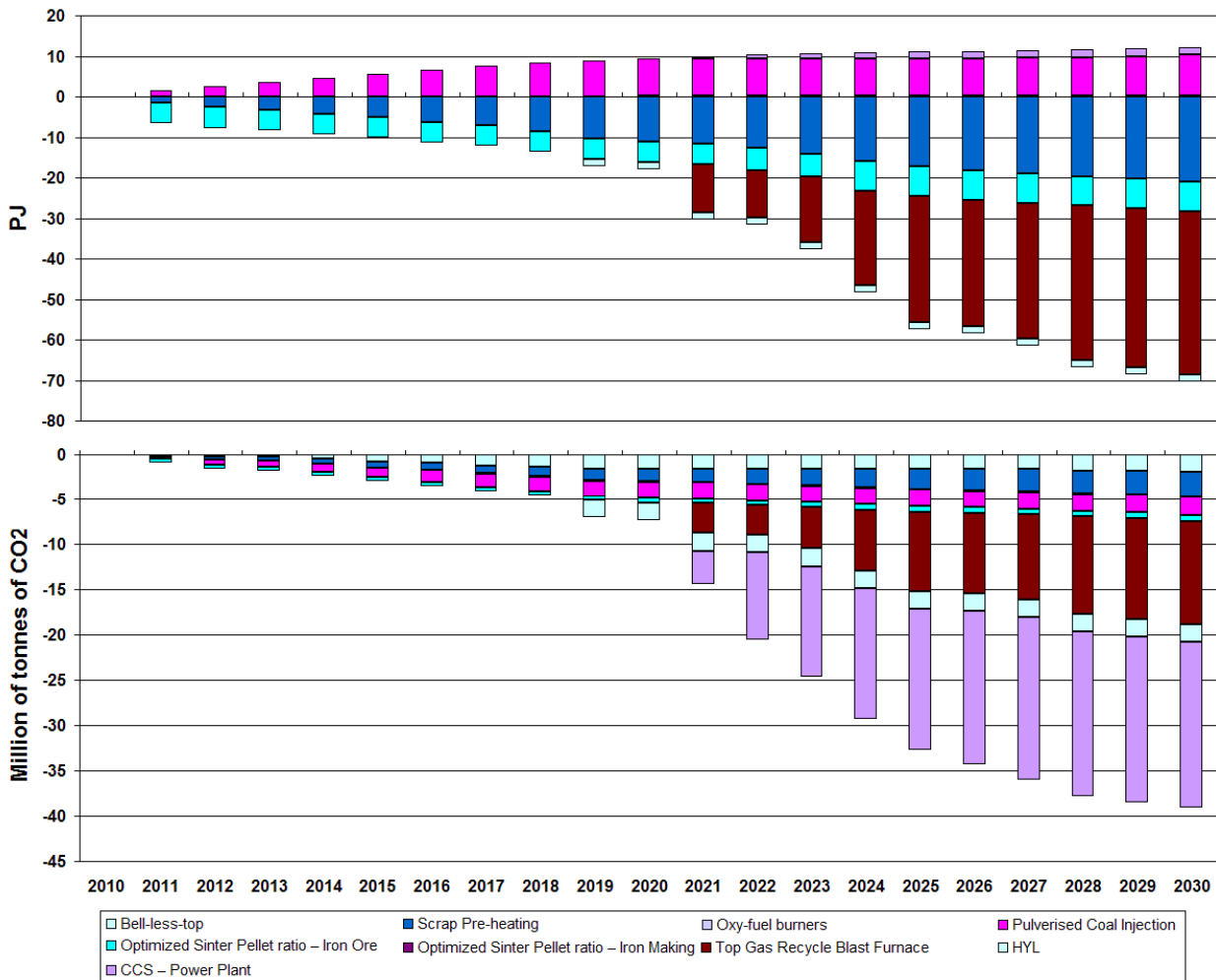
**Figure 14: Difference with the case without retrofits on direct energy consumption and direct CO<sub>2</sub> emissions by technology in the BS scenario for the EU-27 Iron & Steel Industry, and associated power plants, up to 2030**

## 5.2. Alternative Scenario 1 - AS1

The first alternative scenario analyses the impact of the prices of energy and resources in the iron and steel sector, which could be considered one of the main drivers for the incorporation of new technologies. In the model, the savings in energy and resource consumption are achieved by incorporating BATs and ITs into the iron & steel plants, together with the incorporation of New EAF to the pool. Two cases are analysed: case 2x-Fuel, which considers doubling of the final price of the BS in 2030, and case 5x-Fuel, which considers a fivefold increase of the final price of the BS in 2030. In both

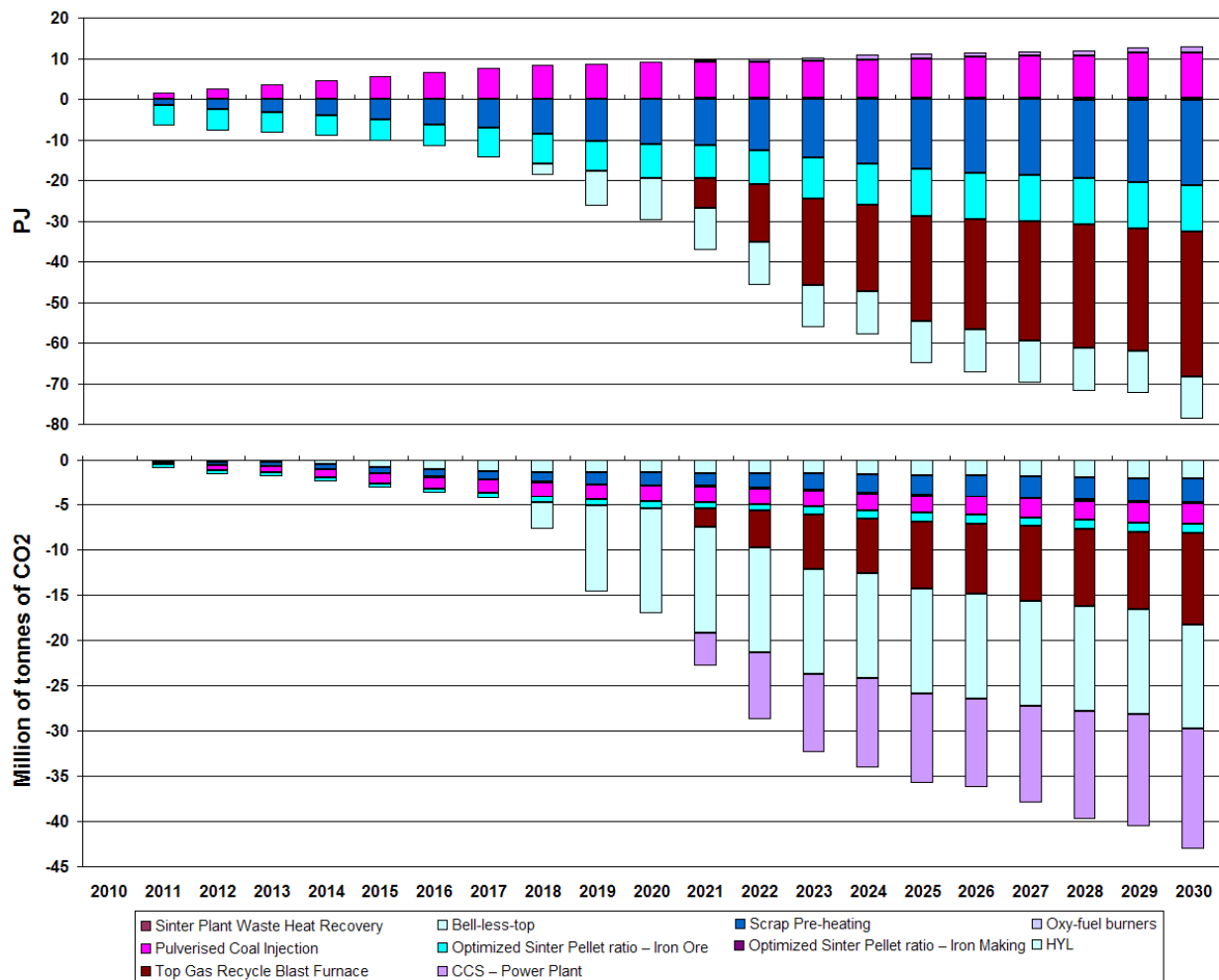
cases, the initial values in 2010 are the same and the values in 2030 are reached following a linear trend.

Figure 15 and Figure 16 show the variation in the total direct energy consumption and the total direct CO<sub>2</sub> emissions by technology along the simulation under the 2x-Fuel and 5x-Fuel scenarios. The type of technologies incorporated by the model follow the same scheme as for the BS scenario, except that the state-of-the-art power plant technology has higher penetration, and under these conditions the HYL becomes cost-efficient in one plant for the 2x-Fuel and in five facilities for the 5x-Fuel scenarios. However, the more successful IT technologies are the CCS in power plants (with 39, 27 and 12 retrofits in the BS scenario, 2x Fuel scenario and 5x-Fuel scenario, respectively), followed by the Top Gas Recycling Blast Furnace (without CCS) which is implemented in 15, 29 and 20 facilities for the BS scenario, 2x Fuel scenario and 5x-Fuel scenario respectively. The impact on total direct energy consumption and total direct CO<sub>2</sub> emissions of the EU-27 iron and steel industry is especially important in the 5x-Fuel scenario. As with the BS scenario, the incorporation of IT technologies accounts for the lion's share of savings, with 69.8% and 80.8% for total direct energy consumption and total direct CO<sub>2</sub> emission respectively in 2030. In the 5x-Fuel scenario these effects are more noticeable because the highest prices of energy and resources are taken into consideration. Under this scenario, the share of IT technologies in the savings of the total direct energy consumption and the total direct CO<sub>2</sub> emissions represent 67.7% and 81.1% respectively in 2030.



**Figure 15: Difference with the case without retrofits on direct energy consumption and direct CO<sub>2</sub> emissions by technology in the 2x - Fuel scenario for the EU-27 Iron & Steel Industry, and associated power plants, up to 2030**





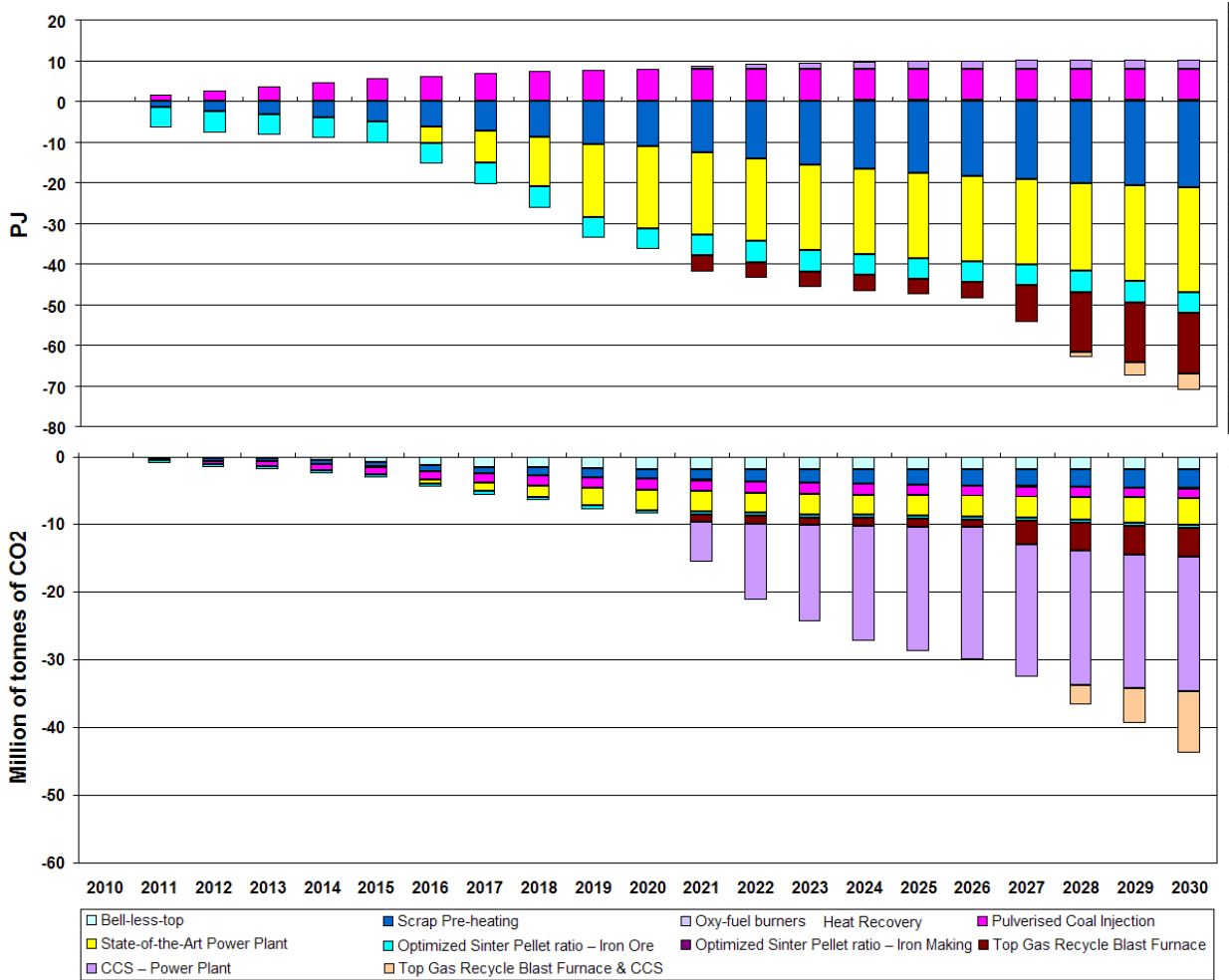
**Figure 16: Difference with the case without retrofits on direct energy consumption and direct CO<sub>2</sub> emissions by technology in the 5x - Fuel scenario for the EU-27 Iron & Steel Industry, and associated power plants, up to 2030**

### 5.3. Alternative Scenario 2 - AS2

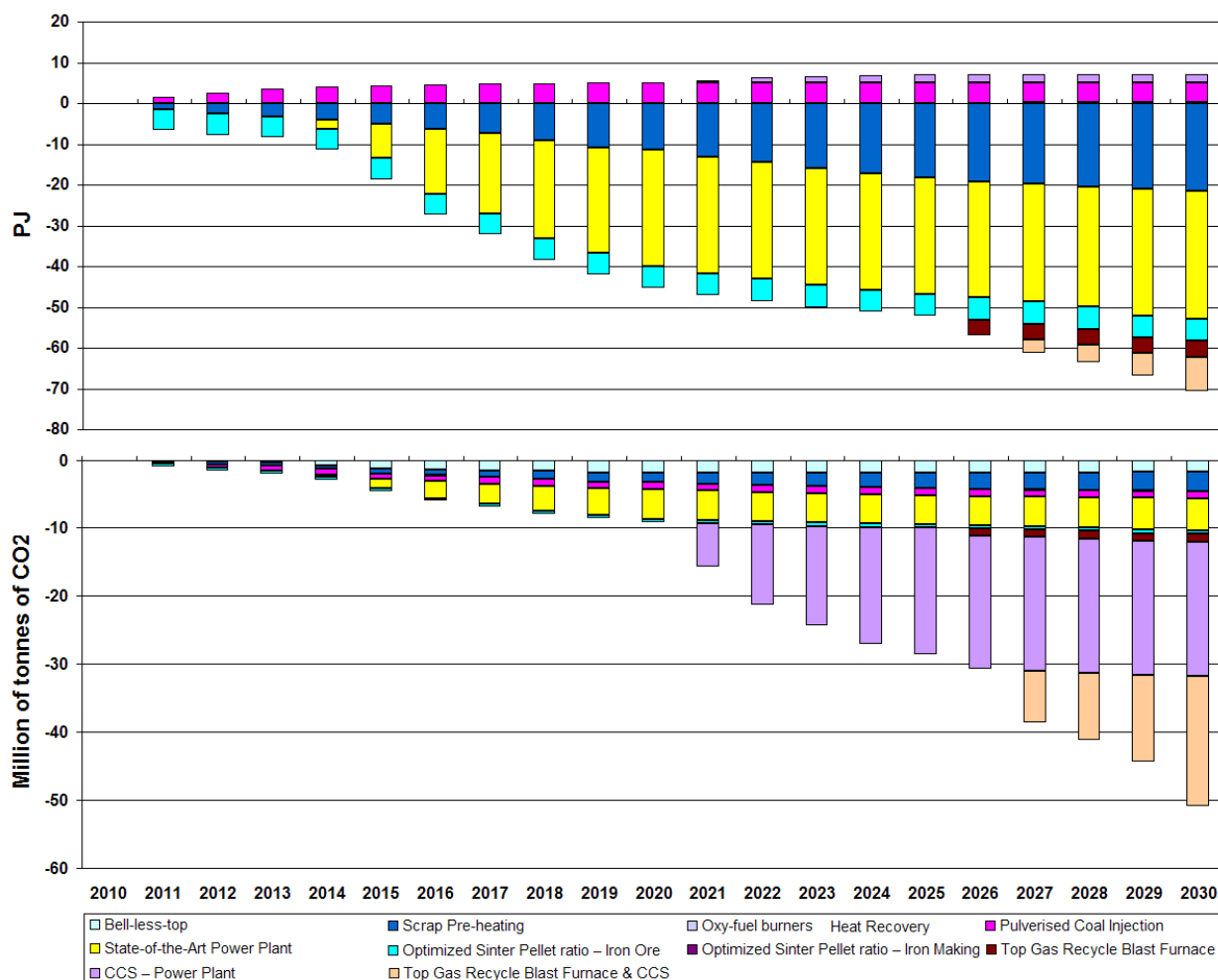
The second alternative scenario studies the effect of the price of CO<sub>2</sub> emissions on the Iron & Steel sector. It is expected that companies will incorporate BATs or ITs that reduce the CO<sub>2</sub> emissions in the Iron & Steel plants to avoid the costs related with the purchase of CO<sub>2</sub> emissions allowances under the European Emission Trading System. Therefore, the expectation is that, the higher the price of allowances, the higher the incorporation of BATs and ITs in the industry. Two cases are analyzed: in both of them the CO<sub>2</sub> price increases linearly, from the same CO<sub>2</sub> price in 2010 to a final price of CO<sub>2</sub> of 100€ per tonne of CO<sub>2</sub> in 2030, case 100€-CO<sub>2</sub>, and to 200€ per tonne of CO<sub>2</sub> in 2030, case 200€-CO<sub>2</sub>.

Figure 17 and Figure 18 respectively show the variation in the total direct energy consumption and the total direct CO<sub>2</sub> emissions by technology along the simulation under the 100€-CO<sub>2</sub> and 200€-CO<sub>2</sub> scenarios. The type of technologies incorporated by the model follow a similar scheme as for the BS scenario, but with a higher penetration of technologies, such as CCS in the power plants associated with the industry; in both scenarios 41 power plants incorporate CCS. In addition, the technology State-of-the-Art Power Plant has an earlier incorporation compared to the BS scenario; it has been incorporated on 18 and 31 occasions in the 100€-CO<sub>2</sub> and 200€-CO<sub>2</sub> scenarios, respectively. The incorporation of CCS in power plants and state-of-the-art power plant hampers the incorporation of other ITs in the industry (due to the restriction of number of compulsory retrofittings applied in the model). Therefore, the Top Gas Recycling Blast Furnace is integrated in only five cases and one case in the 100€-CO<sub>2</sub> and 200€-CO<sub>2</sub> scenarios, respectively.

As in the previous scenarios, IT technologies are key to understanding these reductions, as their impacts represent a share in the savings of 27.4% and 75.48% for the total direct energy consumption and total direct CO<sub>2</sub> emissions, respectively in 2030. For this scenario, the share of IT technologies in the savings of the total direct energy consumption and the total direct CO<sub>2</sub> emissions represent 15.9% and 78.4% respectively in 2030. Note that, in these alternative scenarios, the share of the energy reduction that is due to IT technologies is much lower than for the BS and AS1 scenarios in 2030.



**Figure 17: Difference with the case without retrofits on direct energy consumption and direct CO<sub>2</sub> emissions by technology in the 100€ - CO<sub>2</sub> scenario for the EU-27 Iron & Steel Industry, and associated power plants, up to 2030.**



**Figure 18: Savings, compared to the case without retrofits, on direct energy consumption and direct CO<sub>2</sub> emissions by technology in the 200€ - CO<sub>2</sub> scenario for the EU-27 Iron & Steel Industry, and associated power plants up to 2030**

#### 5.4. Benchmarking curves and trend in specific energy consumption and CO<sub>2</sub> emissions

This section presents the pattern of specific energy consumption and CO<sub>2</sub> emissions per tonne of steel for the integrated and secondary production routes in the iron and steel industry of EU-27. Only the processes linked to the production of the crude steel are taken into consideration. This specific energy consumption and specific CO<sub>2</sub> emissions are the corresponding aggregated amounts of the processes involved up to the end of the Basic Oxygen Furnace for the integrated route, or EAF for the secondary production route. These values exclude the energy consumption and CO<sub>2</sub> emissions of the power plants associated to the industry. Where a facility lacks one or more of the processes required in the integrated route, we have aggregated the average specific consumption of the industry for that process(those processes) in order to reproduce these curves.

The bottom-up approach that was adopted enables the evolution of their specific CO<sub>2</sub> emissions and energy consumption to be studied in each facility when the industry implements cost-effective retrofittings. Thanks to this approach it is possible to construct the evolution of the benchmarking curve of CO<sub>2</sub> emissions. Figure 19 represents these curves for the BS scenario. These curves give the specific CO<sub>2</sub> emissions of the facilities when those facilities are arranged in ascending order of specific emissions. The model produces one benchmarking curve per year.

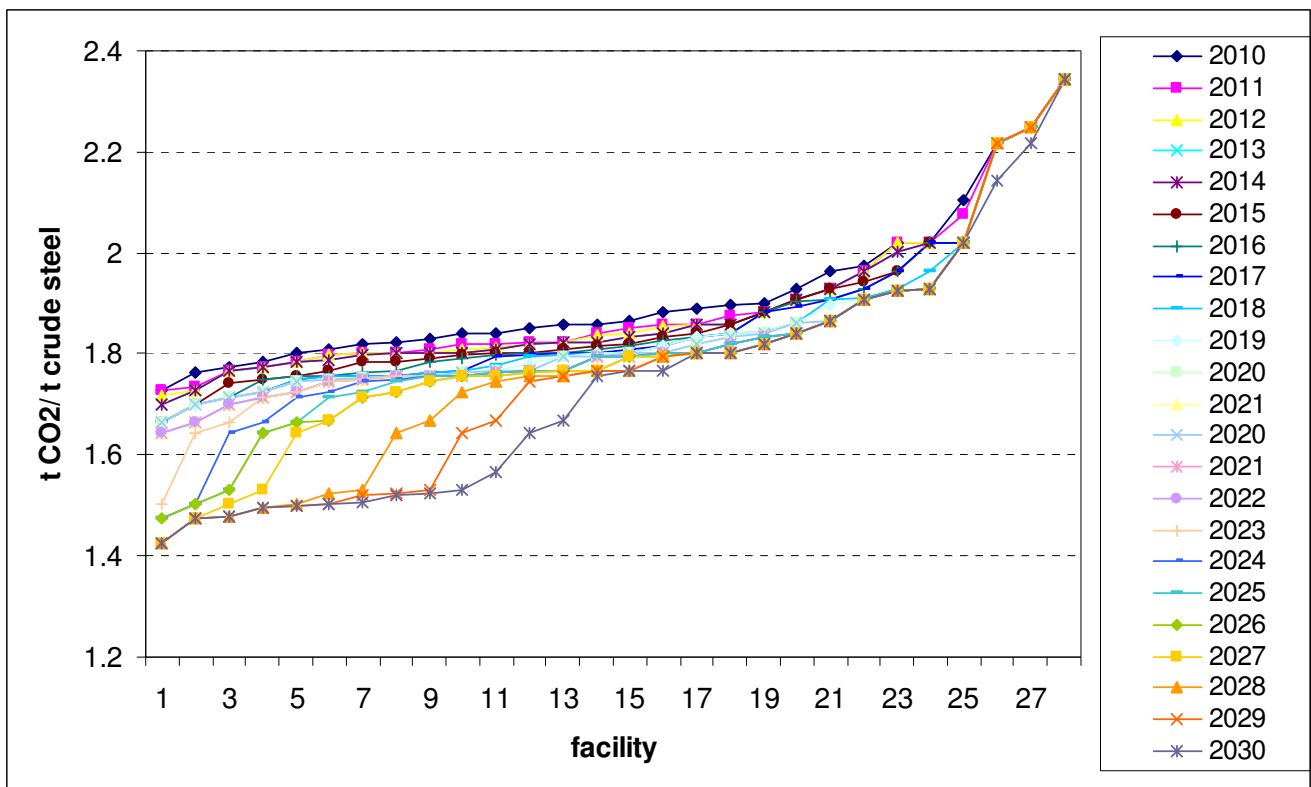
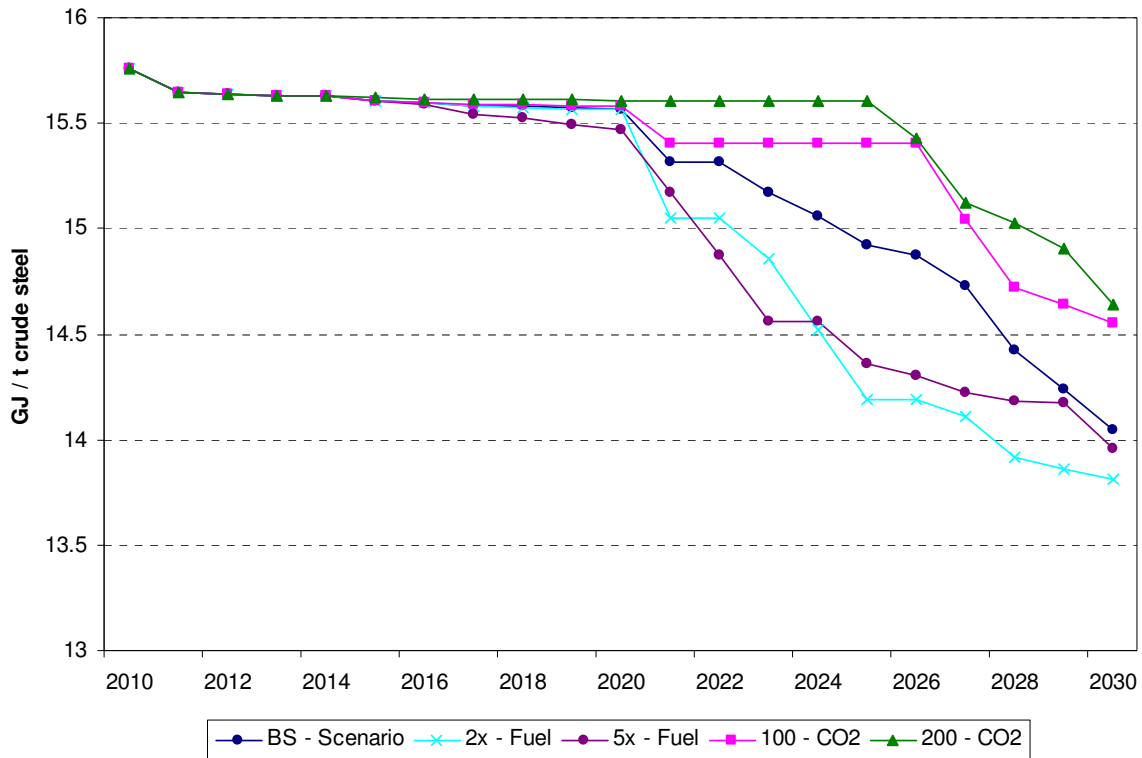


Figure 19. Evolution of the benchmarking curves of specific CO<sub>2</sub> emissions in the BS scenario

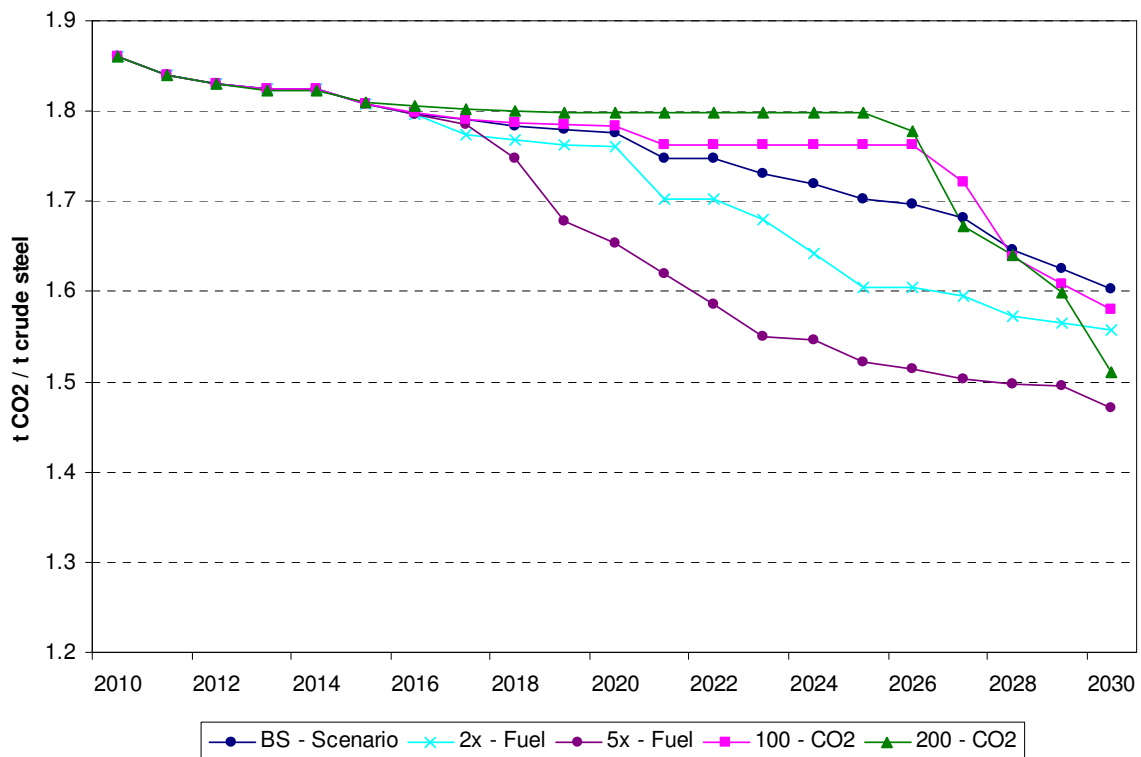
Each point of figure 19 corresponds to one facility. The position of each facility can change from year to year, i.e. from curve to curve. For example, the facility with lower specific CO<sub>2</sub> emissions in 2023 was the third with lower emissions in 2022. In figure 19, there are two groups of facilities emitting around 1.8 and 1.5 t CO<sub>2</sub> /t crude steel. The first value corresponds to the emissions of the best performers of the integrated production route, whereas the second value corresponds to facilities which - from 2020 onwards - involve incorporating Top Gas Recycle Blast Furnace technology.

The information of each curve of figure 19 can be summarised using the average value of the specific emissions (we could equally have used the benchmarking value, as defined in [38], or any other percentile of these curves). Using the average value for all the scenarios analysed, it can set out in Figure 20 and Figure 21 the trend of the average specific energy consumption and specific CO<sub>2</sub> emissions for the integrated production route in the EU-27 iron and steel industry.

The evolution of the specific energy consumption for all the scenarios falls into two clearly distinguished periods: namely from 2010 to 2020 and from 2021 to 2030. During the first period, all the scenarios evolve in quite a similar way. This is because there are only a few IT technologies available prior to 2020. As a result, practically only BAT technologies are incorporated prior to 2020. The 2x-Fuel and 5x-Fuel scenarios are the exceptions where there are one and five incorporations, respectively, of the HYL technology before 2030. In the second period, the availability of IT technologies, mainly the Top Gas Recycle Blast Furnace, contribute to the large reductions in CO<sub>2</sub> emissions and energy consumption seen in figures 20 and 21.



**Figure 20: Evolution of the specific energy consumption for the integrated production route for the scenarios of the EU-27 Iron & Steel Industry up to 2030**



**Figure 21: Evolution of specific CO<sub>2</sub> emissions for the integrated production route for the scenarios of the EU-27 Iron & Steel Industry up to 2030**

For the BS scenario, the evolution of the model between 2010 and 2030 shows an improvement of

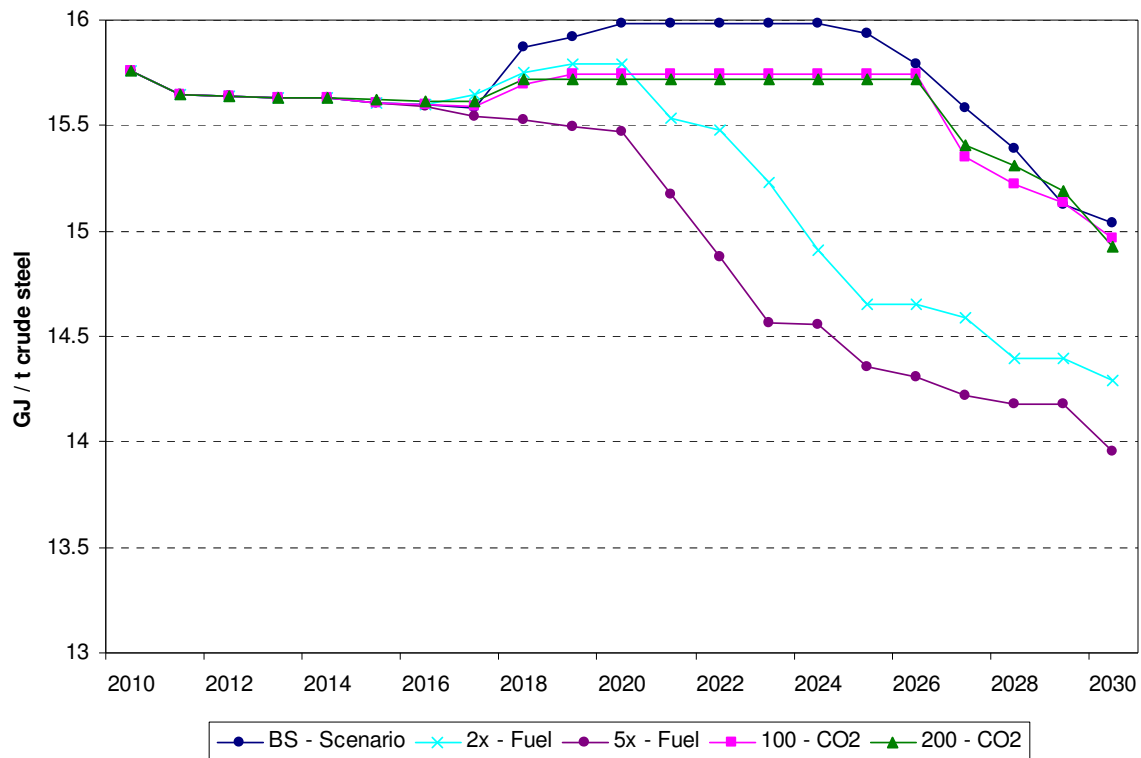
about 11% and 14%, respectively in the specific energy consumption and the specific CO<sub>2</sub> emissions.

For the 2x-Fuel and 5x-Fuel scenarios, the improvements in the specific energy consumption along the simulation are 12% and 11%, respectively, i.e. similar to the BS scenario. The improvement achieved in the specific CO<sub>2</sub> emission is 16% for the 2x-Fuel scenario and 21% for the 5x-Fuel scenario, which represents a slight improvement compared to the BS scenario. The specific CO<sub>2</sub> emissions for these two scenarios remain the lowest during the first part of the second period compared to the other scenarios; this is due to the effect of the HYL technologies incorporated during the first period of the simulation.

For the 100€-CO<sub>2</sub> and 200€-CO<sub>2</sub> scenarios, the specific energy consumption during the first part of the second period has not produced any significant improvements compared to the previous period. The reason is that, in these scenarios, CCS in power plants and efficient power plants will become quite cost-effective soon after 2020. In the model, these retrofittings compete with the other retrofits in the iron and steel industry (the constraint on the annual number of retrofittings permitted hampers other cost-effective ITs in the industry). This reduction in specific CO<sub>2</sub> emissions for 200€-CO<sub>2</sub> is due to the introduction of Top-Gas-Recycling technology with CCS incorporated. In 2030, the reductions in the specific energy consumption for the 100€-CO<sub>2</sub> and 200€-CO<sub>2</sub> scenarios are 8% and 7% respectively, whereas the reductions in specific CO<sub>2</sub> emissions for the same scenarios are 15% and 19%, respectively.

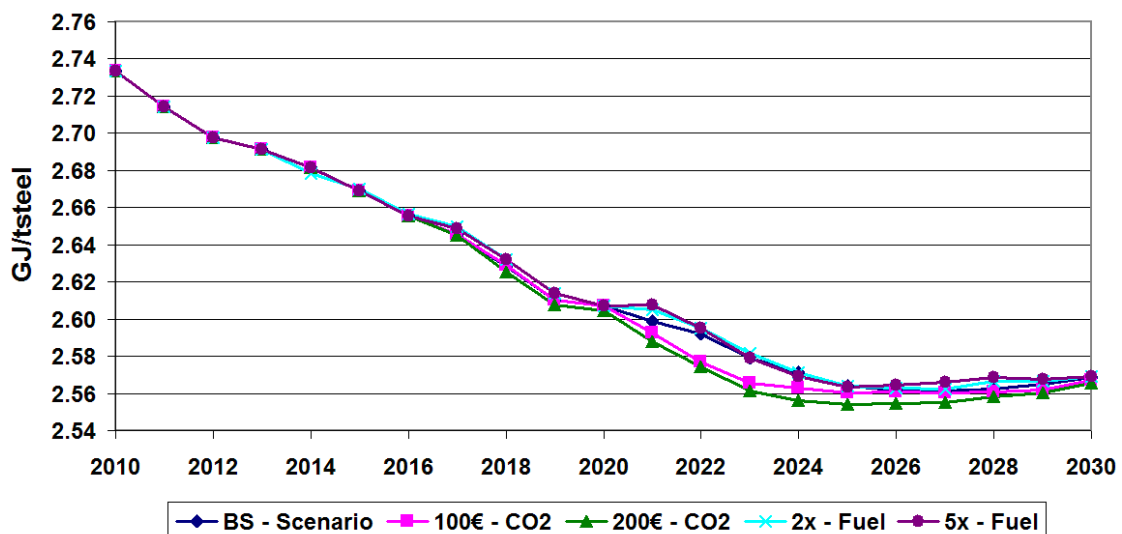
To summarize, it can be concluded that the reductions of specific CO<sub>2</sub> emissions between 2010 and 2030 range from 14% to 21% for the BS and the 5x-fuel scenario respectively. On the other hand, the range of reduction in energy consumption varies between 7% and 11% for the 200€-CO<sub>2</sub> and BS scenarios, respectively.

Although it has not been discussed in detail here, we also checked the effect of including FINEX in scenarios similar to those described so far. In this case, the falls in specific CO<sub>2</sub> emissions between 2010 and 2030 vary from 16% to 21%, and in specific energy the range is between 5% and 7%. Given that the ranges in the paragraph above are similar to these latter ranges, the inclusion/exclusion of this technology does not alter the final outcome of the model by 2030. However, it is worth mentioning that the inclusion of some FINEX processes can make specific energy consumption worse, as Figure 22 shows, when the model includes some of them before 2020. Figure 22 is the 'double' of Figure 20; the only difference is that, in order to obtain figure 22, we have run the model including the implementation of cost-effective FINEX technologies. The corresponding figure of specific CO<sub>2</sub> emissions is omitted because it is quite similar to Figure 21.

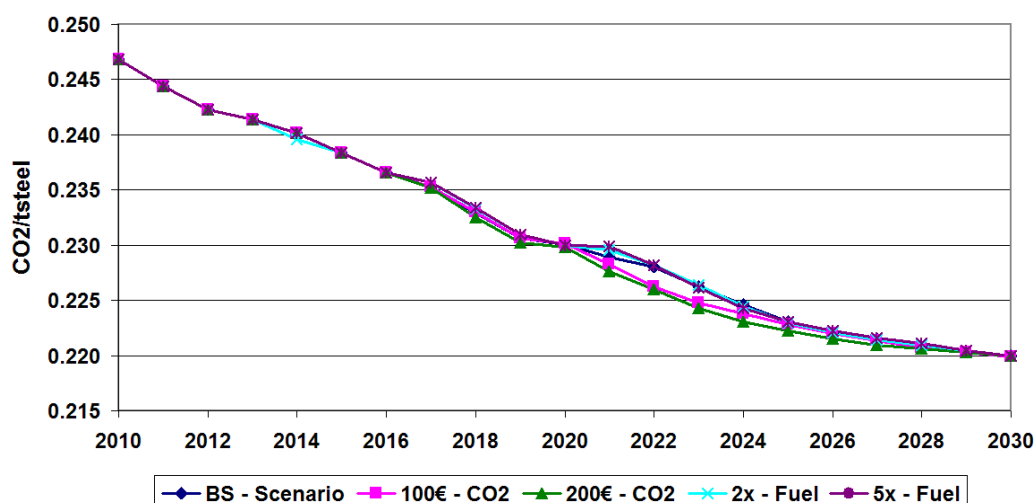


**Figure 22: Trend in the specific energy consumption for the integrated production route for the scenarios of the EU-27 Iron & Steel Industry up to 2030 when FINEX is included.**

Figure 23 and Figure 24 respectively show the evolution of the specific energy consumption and the specific CO<sub>2</sub> emissions model for the secondary production route in the EU-27 iron and steel industry under the different scenarios up to 2030. Specific energy consumption and specific CO<sub>2</sub> emissions for all the scenarios evolve in a similar way. This is because all possible retrofits that offer the only two technologies available in the model (Scrap Pre-heating and Oxy-fuel burners) are already being implemented in the BS scenario. The additional incentives generated by the increase in the cost of the energy and resources (AS1 scenarios) or in the CO<sub>2</sub> emission (AS2 scenarios) do not widen the range of cost effective retrofits, because no more possible retrofits are possible, as they have all been implemented already under the figures for the BS scenario. The decreases attained from 2010 to 2030 amount to 6% and 11% of specific energy consumption and specific CO<sub>2</sub> emissions, respectively.



**Figure 23: Evolution of the specific energy consumption for the secondary production route for the scenarios of the EU-27 Iron & Steel Industry up to 2030**



**Figure 24: Evolution of the specific CO<sub>2</sub> emissions for the secondary production route for the scenarios of the EU-27 Iron & Steel Industry up to 2030**

## 5.5. Policy implications

The technologies considered in this document range from Best Available Technologies (BATs), already available, to Innovative Technologies (ITs), some of them already commercially available (COREX/FINEX, HYL, MIDREX...) and others not (Top Gas Recycling Blast furnace, CCS...). The dissemination of technologies already commercially available should be a private-sector endeavour, mainly driven by market incentives. This document shows that there are some cost-effective opportunities that the industry has not yet implemented; therefore, there is the clear need for the public sector to mitigate the possible barriers that prevent the full deployment of these technologies. Also the public sector could provide a technology-push in the coordinating and co-funding of new and innovative technologies (as ULCOS and CCS). The technology-push (supported through policies that stimulate research and development) in the iron and steel industry may reduce the cost estimated and lessen the uncertainties associated with the energy consumption and CO<sub>2</sub> reduction potential of those technologies. The main aim of the EU Strategic Energy Technology Plan SET-Plan is to speed up the development of a world-class mix of affordable, clean, efficient and low-emission energy technologies by means of coordinated research efforts. In fact, one of the instruments that will support the implementation of the SET-plan is the New Entrance Reserve 300 (NER 300), introduced by Article 10(a)8 of the revised Directive [60]. This instrument will provide the monetary value of €300 Million of CO<sub>2</sub> allowances to co-finance CCS and innovative renewable demonstration projects. Of the 66 projects that have passed the due diligence assessment, two are industrial applications demonstrating CCS on refineries, cement kilns, in iron and steel or aluminum. The award decision will be made by end 2012. [61]. The European Union has maintained activities in research in the Iron & Steel industry under the 7th Framework programme and the Research Fund for coal and steel, and on a minor scale is also launching the Sustainable Industry Low Carbon Scheme, the aim of which is to compensate industries for the lack of competitiveness due to the EU ETS. For all the technologies considered in this work, demand-pull instruments that enhance the use of lower energy consuming technologies, such as emission taxes, adoption subsidies or direct public-sector investments, can increase the incentives of using new cleaner technologies and lower the costs, thanks to the “learning-by-doing” effect.



## 6. Conclusions

The present work analyses the role of technology and its dissemination at plant level in the EU Iron & Steel industry on the basis of a bottom-up sector model. The detailed approach used in the development of this model allows us to provide details of the trend of the benchmarking curves of CO<sub>2</sub> emissions and energy consumption for the industry up to 2030. This provides the JRC with a unique tool able to respond to many specific policy-related questions about the potential evolution of some parameters specific of these curves, such as the benchmarking values defined in [38]. This study considers three different scenarios: a baseline scenario (BS) and two alternative scenarios (AS1 and AS2). The BS scenario studies the trend of CO<sub>2</sub> emissions and energy consumption of the industry when the demand for steel and the prices of fuels and resources evolve according to the projection of the European Commission[22]. The AS1 scenario analyses the influence of an increase of the fuel and resource prices, and the AS2 scenario examines behaviour with respect to variations in the CO<sub>2</sub> emission price.

The AS1 scenario analyses two cases: case 2x-Fuel, which considers a doubling of the final price of the BS in 2030, and case 5x-Fuel, which considers a fivefold increase of the final price of the BS in 2030. In both cases the initial values in 2010 are the same, and the values in 2030 are reached following a linear trend. The AS2 scenario also includes two cases, where the CO<sub>2</sub> price shows a linear increase during the simulation from the same CO<sub>2</sub> price in 2010 to a final price of CO<sub>2</sub> of 100€ per tonne of CO<sub>2</sub> in 2030, case 100€-CO<sub>2</sub>, and to 200€ per tonne of CO<sub>2</sub> in 2030, case 200€-CO<sub>2</sub>.

Taking the primary steel production route, the maximum range of reductions in specific CO<sub>2</sub> emissions between 2010 and 2030 is between 14% and 21%, for the BS and the 5x-fuel case, respectively. On the other hand, in the case of specific energy consumption this range varies between 7% and 11% for the 200€-CO<sub>2</sub> case and BS scenarios, respectively. Where the FINEX/COREX technologies are included, there is practically no improvement in specific CO<sub>2</sub> emissions, and there is only a reduced improvement in specific energy consumption.

Using the secondary production route, the additional incentives generated in the AS1 or AS2 scenarios do not have a significant influence. The reason is that the current conditions represented by the BS scenario are conducive to the inclusion of the only two BATs studied (Scrap Pre-heating and Oxy-fuel). For this route and scenarios, the improvements between 2010 and 2030 in the specific energy consumption and the specific CO<sub>2</sub> emissions are around 6% and 11%, respectively.

In both steel production routes, the values obtained in terms of reducing CO<sub>2</sub> emissions and energy consumption reveal the uncertainty of some of the values assumed (capital cost, date of availability/emissions/energy consumption of some IT). Other possible sources of uncertainty that could affect the results are in some of the assumptions of the model (not more than six major retrofits per year, not more than one major IT allowed in the same location, etc.). Logically, the higher reductions in CO<sub>2</sub> emissions and energy consumption are found in the higher values of some of the parameters used to check the sensitivity of the main drivers of the industry. The drivers checked in this document are the price of CO<sub>2</sub> allowances, fuel and resources. For the higher values of these drivers, the maximum decreases in CO<sub>2</sub> emissions and in energy consumption are around 20% and 10% respectively. These percentages prove that these drivers are ineffective as major levers of change. Therefore, one of the consequences is that only demand-pull measures supported by public authorities (through CO<sub>2</sub> prices) do not appear to be significant in bringing about changes in the industry. The model also shows that, in the primary steel production route, the remaining Best Available Technologies (BATs) studied have little effect in terms of improving CO<sub>2</sub> emissions and energy consumption, and that only new ITs have the potential to substantially alter CO<sub>2</sub> emissions, and energy consumption to only a minor extent. As a consequence, it appears that technology-push on the part of some public authorities (which might alter the date of readiness for market roll-out of some IT, or reduce uncertainty about their costs and characteristics), could be help bring about meaningful changes in the footprint of the industry.

According to the arguments set out in this document, there are still some cost-effective improvements that can be made in the industry, which can have a clear broadening effect in terms of their impact on energy consumption and CO<sub>2</sub> emissions, depending on the successful demonstration of some of the ITs currently under research. This opening up of the range of potential reductions from 2020, when some of the ITs are available, could reveal the importance of the R&D needed in order to make those ITs a reality. Unless the industry implements BATs or IT according to the dissemination rate forecast in this model, there will be an energy-efficiency gap. This gap is not unique to this industry, and it shows the difference between what can be done cost-effectively and what is actually being done. The barriers that can prevent the industry from achieving these improvements include global competition, widespread fluctuation in energy prices, and uncertainties about future energy prices. How to mitigate these barriers is one of the challenges facing policy-makers. In the course of this work, a tool has been developed that enables us to analyse these effects in a level of detail which has not been available hitherto.

## 7. Bibliography

- [1] European Commission, Analysis of options to move beyond 20% greenhouse gas emission reductions and assessing the risk of carbon leakage; 2010. Available from: <http://eur-lex.europa.eu>.
- [2] European Commission, Strategic Energy Technology Plan (SET-Plan); 2010. Available from: <http://ec.europa.eu>.
- [3] European Commission. Europe 2020 - a strategy for smart, sustainable and inclusive growth; 2010. Available from: <http://ec.europa.eu>.
- [4] European Commission. IPPC directive; 2008. Available from: <http://eur-lex.europa.eu>.
- [5] M. Arens, Energy efficiency and CO<sub>2</sub> emissions reduction in the steel industry, EFONET Workshop 4.3: Increasing energy efficiency in industrial processes. Berlin, 2010.
- [6] Ecofys. Fraunhofer Institute for Systems and Innovation Research, Öko-Institut. Methodology for the free allocation of emission allowances in the EU ETS post 2012. Sector report for the Iron and Steel industry. November 2009.
- [7] P. van Vuuren, B.J. Strengers, H.J.M. de Vries. Long-term perspectives on world metal use - a model-based approach. RIVM - National Institute of Public Health and the Environment RIVM report 461502 021, 1999.
- [8] P. Crompton. Forecasting steel demand in South-East Asia. Department of Economics, University of Western Australia, 1998.
- [9] P. Crompton. Future trends in Japanese steel consumption. Resources Policy (26), 103-114, 2000.
- [10] P. Crompton. The diffusion of new steelmaking technology. Resources Policy (27), 87-95, 2001.
- [11] D.J. Gielen, A.W.N. van Dril. The basic metal industry and its energy use. Prospects for the Dutch energy intensive industry. ECN - The Netherlands Energy Research Foundation ECN-C-97-019, 1997.
- [12] D.J. Gielen, Y. Moriguchi. Environmental strategy design for the Japanese Iron and Steel industry - A global perspective. National Institute of Environmental Studies, 2001.
- [13] D.J. Gielen, Y. Moriguchi. CO<sub>2</sub> in the Iron and Steel industry: an analysis of Japanese emission reduction potentials. Energy Policy (30), 849-865, 2002.
- [14] M.M. Costa, R. Schaeffer, E. Worrell. Exergy accounting of energy and material flows in steel production systems. Energy (26), 363-384, 2001.
- [15] N. Martin, E. Worrell, M. Ruth, L. Price, R. N. Elliott, A.M. Shipley, J. Thorne. Emerging energy-efficient industrial technologies. Lawrence Berkeley National Laboratory LBNL-46990, 2000.
- [16] L. Ozawa, C. Sheinbaum, N. Martin, E. Worrell, L. Price. Energy use and CO<sub>2</sub> emissions in Mexico's Iron and Steel industry. Energy (27), 225-239, 2002.
- [17] K. Schumacher, J. Sathaye. India's Iron and Steel Industry: Productivity, Energy Efficiency and Carbon Emissions. Lawrence Berkeley National Laboratory LBNL-41844, 1998.
- [18] E. Worrell, N. Martin, L. Price. Energy Efficiency and Carbon Dioxide Emissions Reduction opportunities in the US Iron and Steel Sector. Lawrence Berkeley National Laboratory LBNL-41724, 1999.

- [19] K. Wang, C. Wang, X. Lu, J. Chen, Scenario analysis on CO<sub>2</sub> emissions reduction potential in China's Iron and Steel industry, *Energy Policy* (35), 2320–2335, 2007.
- [20] K. Schumacher, R.D. Sands. Where are the industrial technologies in energy–economy models? An innovative CGE approach for steel production in Germany. *Energy Economics* (29), 799–825, 2007.
- [21] T. Okazaki, M. Yamaguchi. Accelerating the transfer and diffusion of energy saving technologies steel sector experience—Lessons learned. *Energy Policy* (39), 1296–1304, 2011.
- [22] European Commission. European energy and transport trends to 2030 – update 2009; 2011. Available from: [www.ec.europa.eu](http://www.ec.europa.eu).
- [23] IEA, International energy Agency. Worldwide Trends in Energy Use and Efficiency – key insights from IEA indicator analysis, Paris, 2008.
- [24] European Commission. Final Report of the Set-Plan workshop on Technology Innovations for Energy efficiency and Greenhouse Gas (GHG) emissions reduction in the Iron and Steel Industries in the EU-27 up to 2030. 2010.
- [25] M. Yellishetty, P.G. Ranjith, A. Tharumarajah. Iron Ore and Steel Production Trends and Material Flows in the World: Is this really sustainable? *Resources, Conservation and Recycling* (54), 1084-1094, 2010.
- [26] World Steel Association. Steel and energy-fact sheet energy; 2009. Available at: [www.worldsteel.org](http://www.worldsteel.org)
- [27] Y. Kim, E. Worrell. International Comparison of CO<sub>2</sub> emission trends in the iron and Steel Industry. *Energy policy* (30), 827-838, 2002.
- [28] World Steel Association. Steel Statistical Yearbook 2008. Worldsteel Committee on Economic Studies, Brussels, 2009.
- [29] Eurofer. European steel in figures, 2005-2009. Brussels; 2009. Available from: <http://www.eurofer.org>.
- [30] Steel Institute VDEh, Statistics of the European Iron & Steel sector, 2009. Available from: [www.vdeh.de](http://www.vdeh.de).
- [31] Platts. Plant Electric Power database, 2011. Available from: [www.platts.com](http://www.platts.com).
- [32] C.J. Cairns, H.C de Chily. Energy use in steel industry, International Iron and Steel Institute, 1998.
- [33] R. Schmitt. Electric Arc Furnace Scrap Preheating. Electric Power Research Institute CMP, 1997.
- [34] World Steel Association. CO<sub>2</sub> emissions data collection; 2011. Available from: [www.worldsteel.org](http://www.worldsteel.org).
- [35] ULCOS. Ultra–Low Carbon dioxide (CO<sub>2</sub>) Steelmaking; 2011. Available from: [www.ulcos.org](http://www.ulcos.org).
- [36] K. Meijer. ULCOS: ultra-low CO<sub>2</sub> steelmaking, *Ironmaking and Steelmaking* (36), 2009.

- [37] J.P. Birat, J.P. Lorrain, Y. de Lassat. The CO<sub>2</sub> Tool: CO<sub>2</sub> emissions & energy consumption of existing & breakthrough steelmaking routes. La Revue de Métallurgie (9), 325-336, 2009.
- [38] European Commission. C(2011) 2772 final COMMISSION DECISION of 27.4.2011 determining transitional Union-wide rules for the harmonised free allocation of emission allowances pursuant to Article 10a of Directive 2003/87/EC
- [39] World Steel Association. Short Range Outlook Apparent Steel. Available from: [www.worldsteel.org](http://www.worldsteel.org).
- [40] Steel Consult International. Estimation of the scrap availability from World Steel Association Statistical year books; 2011. [www.steelconsult.org](http://www.steelconsult.org).
- [41] R.N. Elliot. Energy investment decisions in the industrial sector; 2007. Available from: [www.eia.doe.gov](http://www.eia.doe.gov).
- [42] J.P. Birat. CO<sub>2</sub>-lean steelmaking : ULCOS, other international programs and emerging concepts. 1<sup>st</sup> EECR Steel Congress, Düsseldorf, 2011.
- [43] W.D. Seider, J.D. Seader, D.R. Lewin. Product & Process Design Principles. 2<sup>nd</sup> ed. New York: Wiley; 2004.
- [44] Danieli-Corus. Estimation of the transport cost in the Iron & Steel industry, 2010.
- [45] S. Ishihara. Recent operation of Coke Dry Quenching Plants in Japan. IISI Technco Conference, Helsinki, 1982.
- [46] N. Dunker, P. Kamp, H. Opdenwinkel, J. Strunk. The Coke Dry Quenching Plant of the Kaiserstuhl Cokemaking Facility. Coke Making International, 1995.
- [47] Asean Energy Centre. BOF gas sensible heat recovery apparatus; 2010. Available from: [www.aseanenergy.org](http://www.aseanenergy.org).
- [48] Danieli-Corus. Estimation of the cost of the best available technologies and innovative technologies, 2010.
- [49] E. Worrel, N. Martin, L. Price. Energy Efficiency and Carbon Dioxide Emissions, Reduction Opportunities in the U.S. Iron and Steel Sector, Berkeley National Laboratory, 1999
- [50] International Panel Climate Change - IPCC, Reference Document for Best Available Techniques on the Production of Iron and Steel, European commission Integrated Pollution Prevention and Control; 2009. Available from: [www.ipcc.org](http://www.ipcc.org).
- [51] IEA, International energy Agency. Project cost of generating electricity. 2010. Available from: [www.iea.org](http://www.iea.org).
- [52] C. Hendriks, W. Graus, F. van Bergen. Global Carbon Dioxide Storage Potential and Costs; 2004. ECOFYS/TNO report EEP-02001.
- [53] D. Gielen. CO<sub>2</sub> removal in the iron and steel industry. Energy conversion and Management (44), 1027-1037, 2003.
- [54] European Commission. Eurostat statistics; 2010. Available from: [www.epp.eurostat.ec.europa.eu](http://www.epp.eurostat.ec.europa.eu).
- [55] Steel Business Briefing. Estimation of the resources for the Iron & Steel industry; 2010. Available from: [www.steelbb.com](http://www.steelbb.com).

[56] TEX Report. Estimation of the resources for the Iron & Steel industry; 2010. Available from: [www.texreport.co.jp](http://www.texreport.co.jp).

[57] International Panel for Climatic Change – IPCC. Climate Change 2007: Working Group III: Mitigation of Climate Change – Carbon Leakage; 2007. Available from: [www.ipcc.ch](http://www.ipcc.ch)

[58] European Commission. Directorate General Climate Action - Emission trading system (EU ETS); 2011. Available from: [www.ec.europa.eu](http://www.ec.europa.eu).

[59] UNIDO - United Nations Industrial Development Organization. Statistics on wages in manufacturing of basic Iron & Steel; 2006. Available from: [www.unido.org](http://www.unido.org).

[60] DIRECTIVE 2009/29/EC OF THE EUROPEAN PARLIAMENT AND OF THE COUNCIL  
of 23 April 2009 amending Directive 2003/87/EC so as to improve and extend the greenhouse gas  
emission allowance trading scheme of the Community

[61] European Commission. Directorate General Climate Action. M. Doppelhammer. “CCS-Directive and  
NER300 – State of play” 7th CO2 GeoNET Open Forum. Venice, 17-19 April 2012.







European Commission

**EUR 25543 – Joint Research Centre – Institute for Energy and Transport**

**Title: Prospective Scenarios on Energy Efficiency and CO<sub>2</sub> Emissions in the EU Iron & Steel Industry**

**Author(s): N. Pardo, J.A. Moya, K. Vatopoulos**

Luxembourg: Publications Office of the European Union

2012 – 41x pp. – 21.0 x 29.7 cm

EUR – Scientific and Technical Research series – ISSN 1018-5593 (print), ISSN 1831-9424 (online)

ISBN 978-92-79-26971-4 (pdf)

ISBN 978-92-79-26972-1 (print)

doi:10.2790/64264

### **Abstract**

The present work analyzes on the basis of a detailed bottom-up model the role of technology and its diffusion on energy consumption and CO<sub>2</sub> emissions at plant level in the EU-27 Iron & Steel industry. Main current processes of all plants and the cost-effectiveness of their retrofit with Best Available Technologies and Innovative Technologies is analyzed up to 2030

The baseline scenario considers the demand for steel and prices of fuels and resources evolve according to the projection of Primes. Two alternative scenarios vary linearly several times by 2030 some of the main drives of technology change, such as the cost of CO<sub>2</sub> allowances, fuels and price of the resources. The reduction ranges for the specific CO<sub>2</sub> emissions varies between 14% and 21%. The range for the variation in specific energy consumption goes from 7 to 11%. The higher values rely on the successful market roll-out by 2020 of some key innovative technologies, underlining the importance of the successful conclusion of the research ongoing in those technologies. In the recycling route the results indicate potential improvements between 2010 and 2030 in the specific energy consumption and specific CO<sub>2</sub> emissions of about 6% and 11%, respectively.

As the Commission's in-house science service, the Joint Research Centre's mission is to provide EU policies with independent, evidence-based scientific and technical support throughout the whole policy cycle.

Working in close cooperation with policy Directorates-General, the JRC addresses key societal challenges while stimulating innovation through developing new standards, methods and tools, and sharing and transferring its know-how to the Member States and international community.

Key policy areas include: environment and climate change; energy and transport; agriculture and food security; health and consumer protection; information society and digital agenda; safety and security including nuclear; all supported through a cross-cutting and multi-disciplinary approach.

